



# 3D Digitization & Cultural Heritage

Prof. Pelle Snickars

Department of Culture and Media Studies / Humlab

Umeå University

Lviv, September 12, 2019



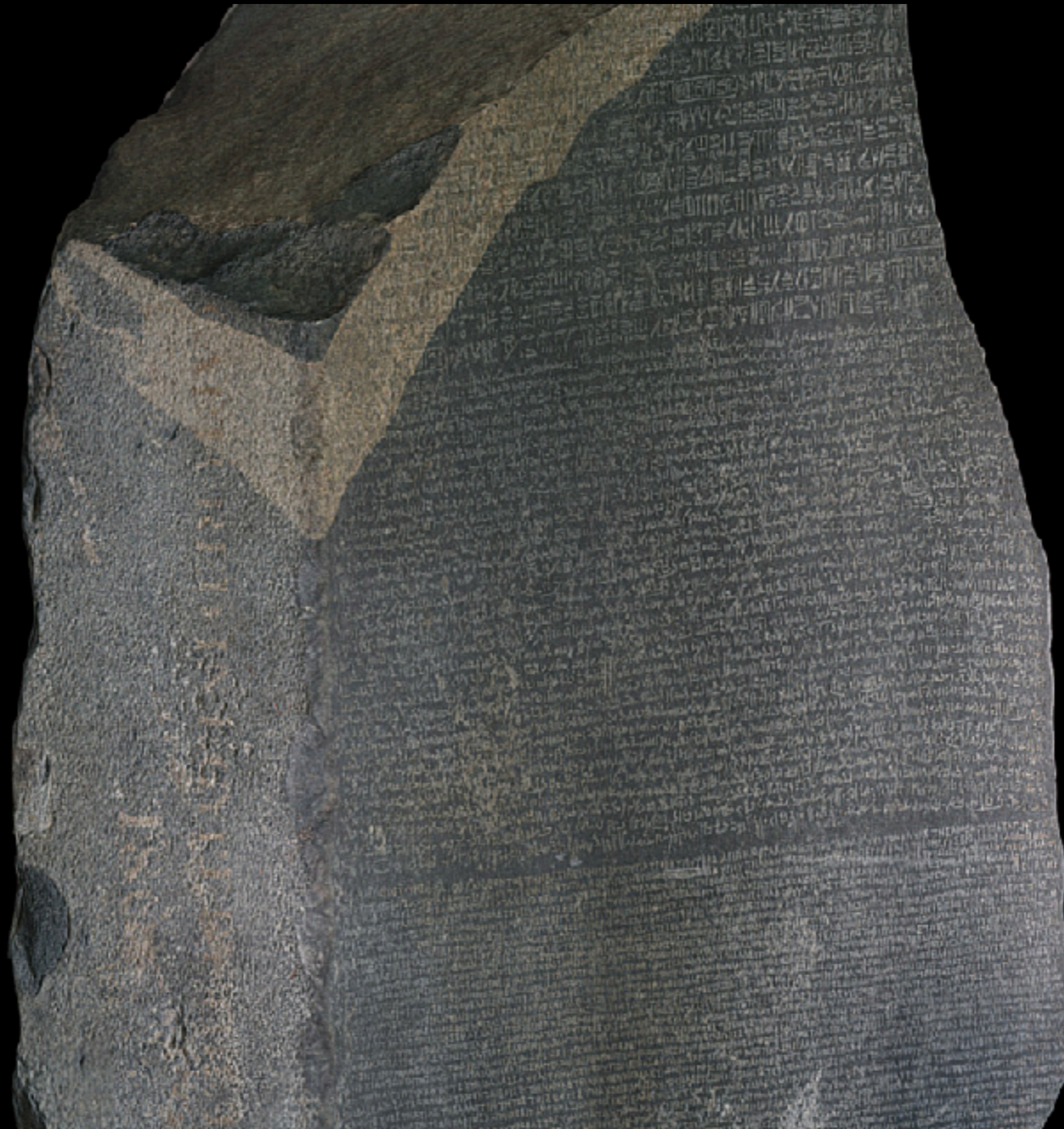



# Cultural Heritage & Media



Asib.

STONEHENGE AS SEEN FROM A WAR BALLOON.

*Published by the Society of Antiquaries of London, 1907.*

35









136a

169



## Digital Collections

### Featured Content



Historic American Buildings Survey/Historic American Engineering...



Chronicing America: Historic American Newspapers



Farm Security Administration/Office of War Information ...

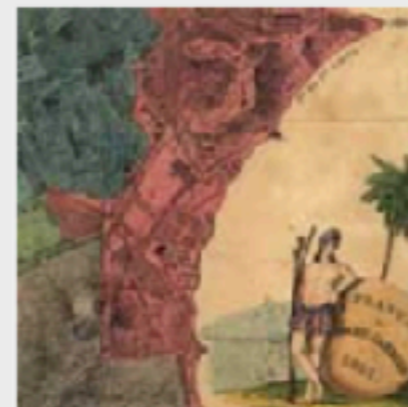

Cities and Towns



Civil War Maps





N:o 15. Stockholm.

KGL. BIBLIOTEKET.

J. Jørgen. Kgl. Hoffotograf.









RESEARCH PROJECTS ON

# DIGITISATION AND ACCESSIBILITY OF CULTURAL HERITAGE





**WELFARE STATE ANALYTICS**  
Text Mining and Modeling Swedish  
Politics, Media & Culture, 1945-1989



**SHARING THE VISUAL  
HERITAGE**  
Metadata, reuse and interdisciplinary  
research



**SWEDISH CARIBBEAN  
COLONIALISM**  
And Atlantic studies, Slave Trade, Slave  
Law, Abolition of Slavery, Caribbean  
social history, Digital Humanities,  
Digitization, Metadata



**ANCIENT IMAGES 2.0**  
A digital edition of the gotlandic picture  
stones



**EXPANSION AND DIVERSITY**  
Digitally mapping and exploring  
independent performance in  
Gothenburg 1965-2000



**SPEAKING TO ONE'S  
SUPERIORS**  
Petitions as cultural heritage and sources  
of knowledge





**3D-modeling of both places & museum objects**





# The British Museum PRO 📍 London, UK

A museum of the world, for the world.

[+ FOLLOW](#)

[CONTACT](#)



15.3k Followers

75 Followings

[SUMMARY](#)

255 MODELS

COLLECTIONS

59 LIKES

## POPULAR 3D MODELS

[View all \(255\)](#) >



 Granite head of Amenemhat... 👁️ 125.6k 💬 54 ★ 719



 Hoa Hakananai'a 👁️ 40.7k 💬 22 ★ 424

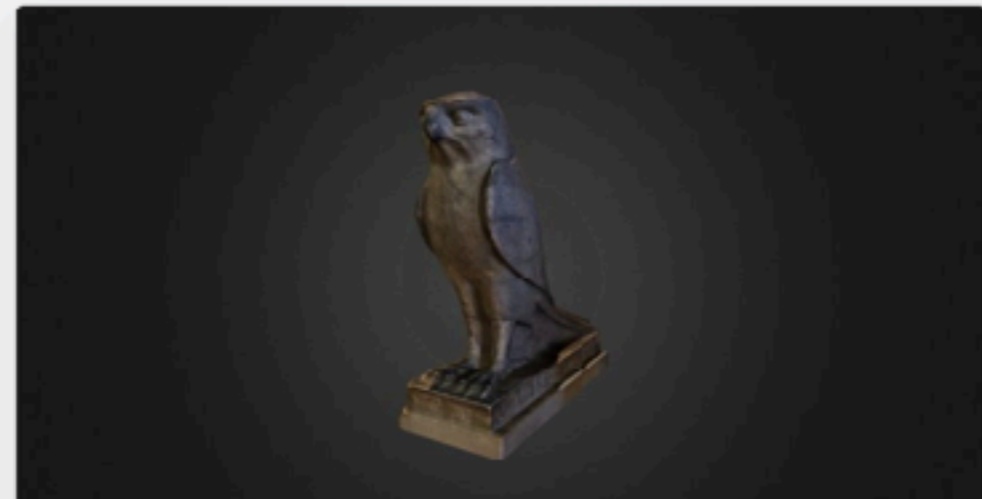
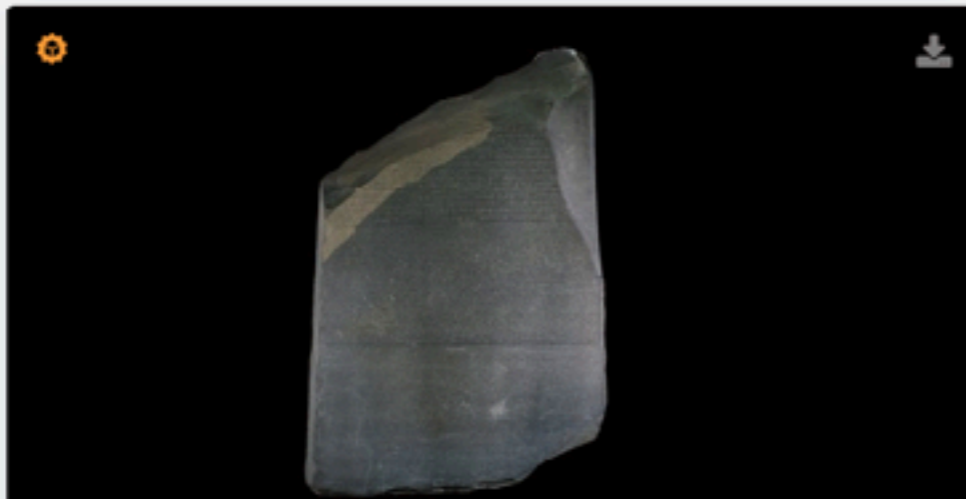



... but analogue models were once also common ...

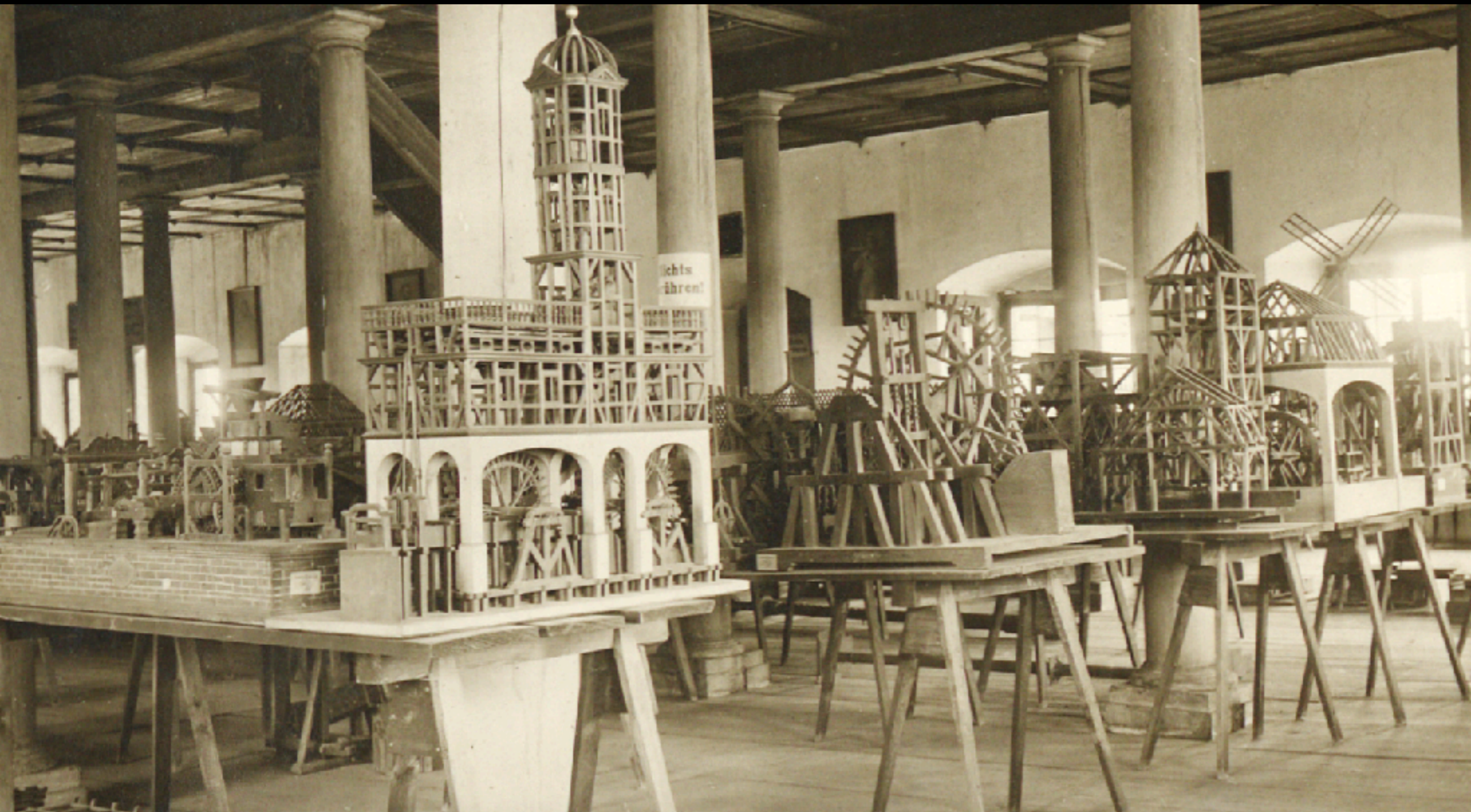



Städt. Modellsammlung, Augsburg.

Holzmodell eines Brunnenhauses mit  
Brunnenturm & Druckwerk.

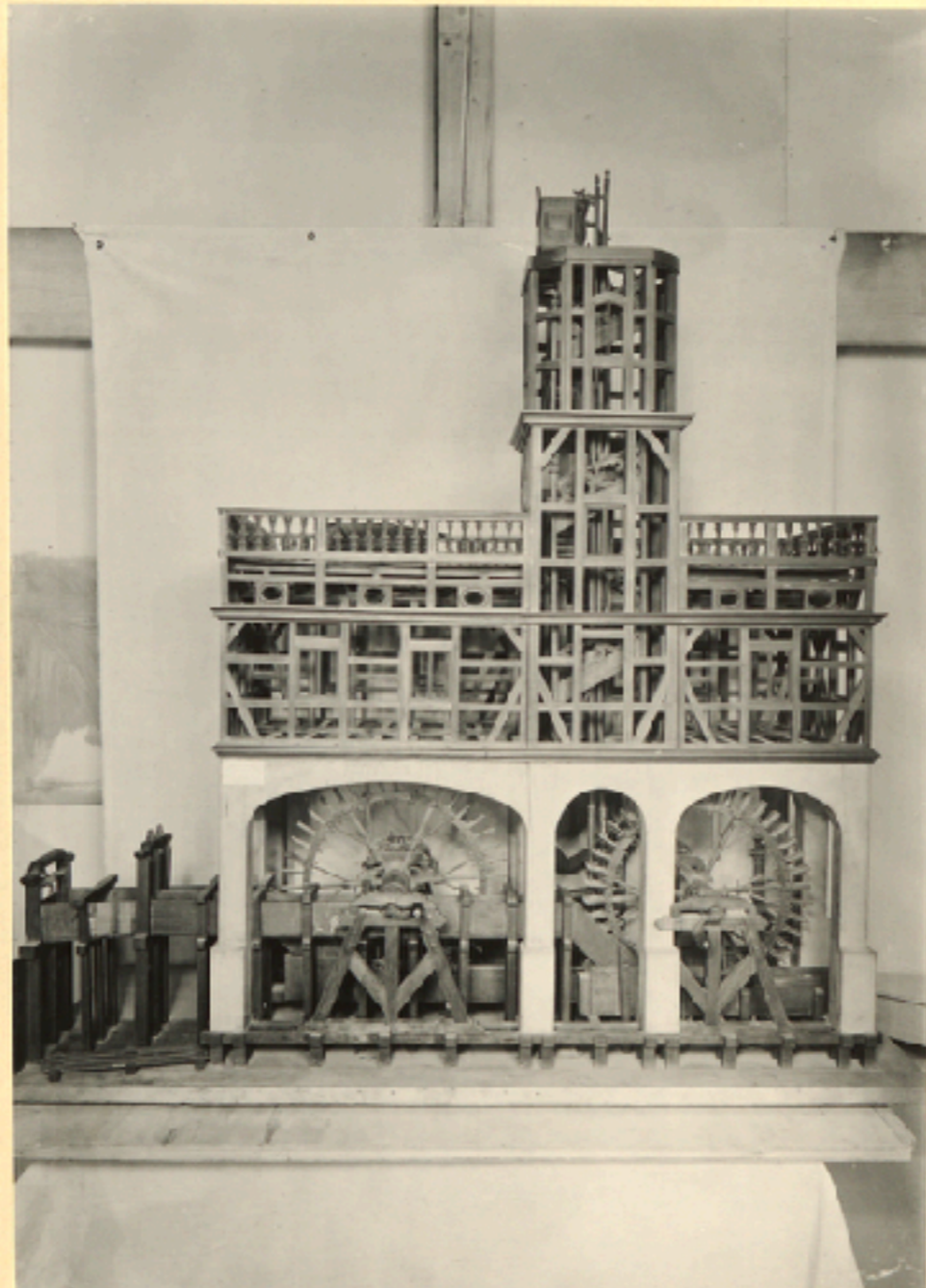



# Theorizing Digital Cultural Heritage

A Critical Discourse

edited by Fiona Cameron and Sarah Kenderdine





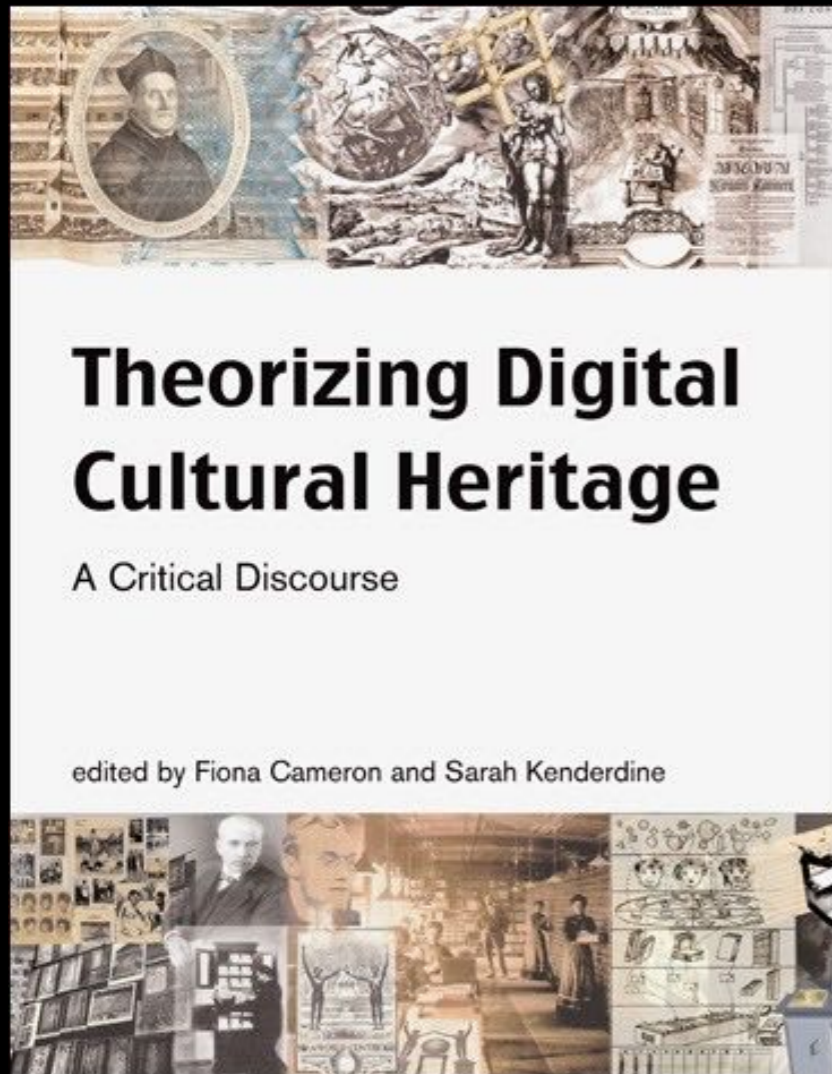

If, as Fiona Cameron once argued, museum culture is perceived as series of practices for defining “object value and meaning”, and particularly so regarding the concepts of “material authenticity, originality, and aura”, then digitisation is (and has always) been a threat—the digital object as a “terrorist”, as Cameron alluringly put it.



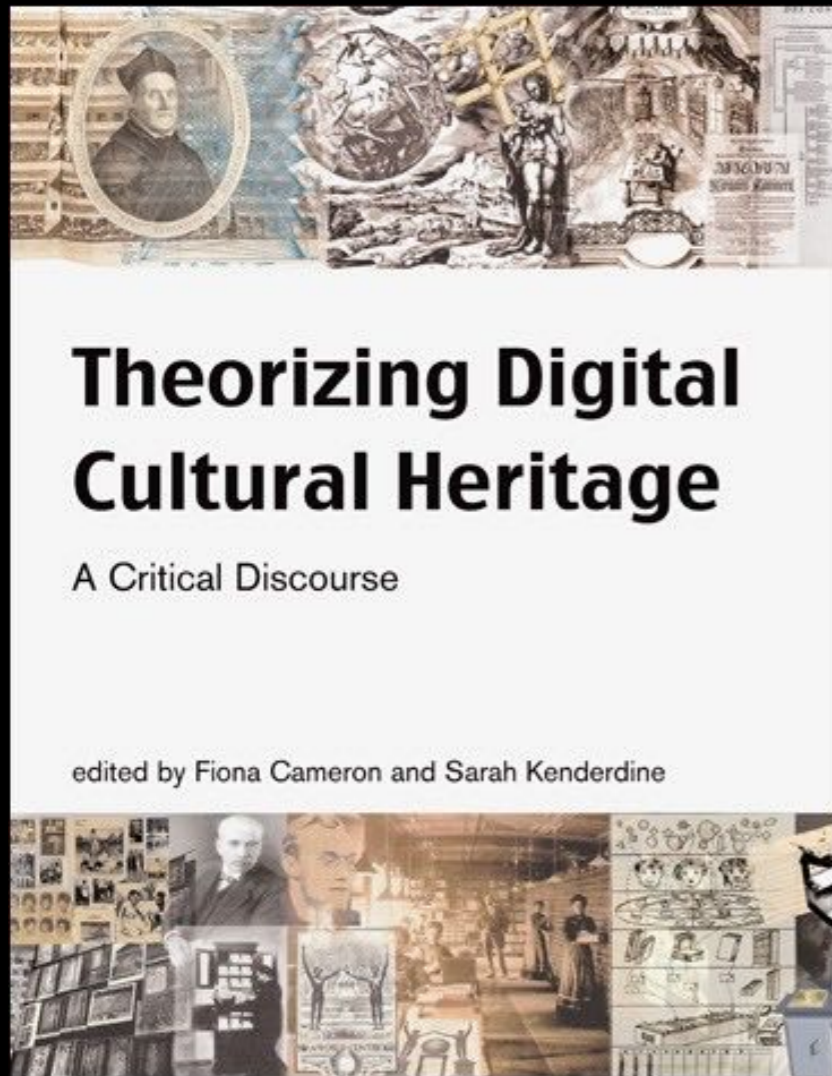

Such an “apocalyptic view of the material/immaterial relationship” was according to her (ten years ago) based on the fear “that as 3D simulations become more convincing, surrogates will merge in ‘form’ ... with the physical object, and viewers unable to perceptually distinguish the replica from the real. Collections could then become obsolete, thus undermining museum culture and practice.”



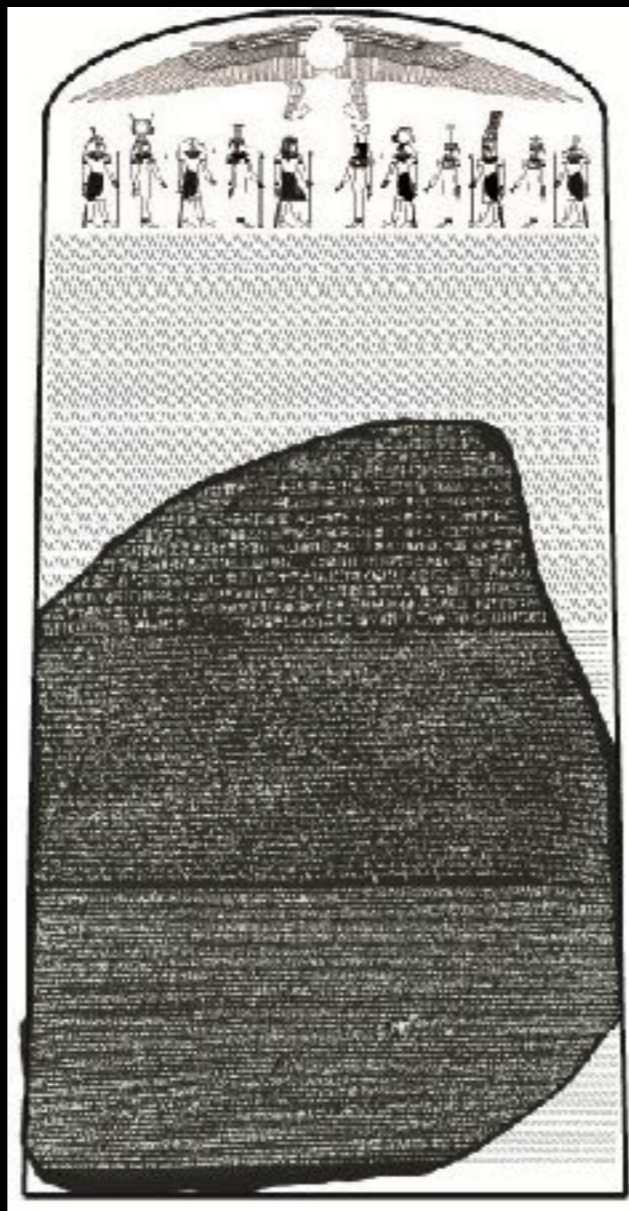

Traditionally, museum culture have underscored the difference in classification between originals and reproductions—with digitisation *by nature* belonging to the latter.





copy or original?



A 3D digital reconstruction of a stone tablet, possibly an ancient tablet with inscriptions. The tablet is shown in a perspective view, highlighting its irregular shape and textured surface. The text on the tablet is rendered in a light, semi-transparent font, making it difficult to read. The background is a solid black color.

**3D as digital image reproduction**





Med utgångspunkt i Tekniska museets samlingar utforskar vi den digitala teknikens möjligheter att omgestalta industrialiseringens berättelser om samhälle, människor och miljöer.



### Modell 1: Sahlins arkiv

Vår bild av industrialismen är fast cementerad i berättelser om framsteg, materiell utveckling och manliga bedrifter. Hur kan digital teknik hjälpa till att finna nya ingångar till befintliga samlingar, samt att nyansera och problematisera bilden av industrialismen?



### Modell 2: Dædalus

Dædalus är en årsbok som alltsedan 1931 har publicerats av Tekniska museet. Projektmodell 2 handlar om att massdigitalisera denna tidskrift och studera dess totala textmängder i jakt efter lingvistiska och teknik-, miljö-, medie- och genushistoriskt signifikanta mönster.



### Modell 3: Polhems alfabet

Kan man utvinna ny historisk kunskap ur Christopher Polhems mekaniska alfabet som digital modell - och samtidigt använda artefakterna för pedagogiska ändamål som svarar mot samtidens behov?





The research project “Digital Models. Techno-historical collections, digital humanities & narratives of industrialisation” is a collaboration between the Swedish National Museum of Science and Technology—located in Stockholm and with a national responsibility Sweden’s technical and industrial heritage—and the digital humanities hub, Humlab at Umeå University.



Based on selected parts of the Technical museum's collections the project explores the potential of digital technologies to reframe Swedish industrialisation and its stories about society, people and environments.





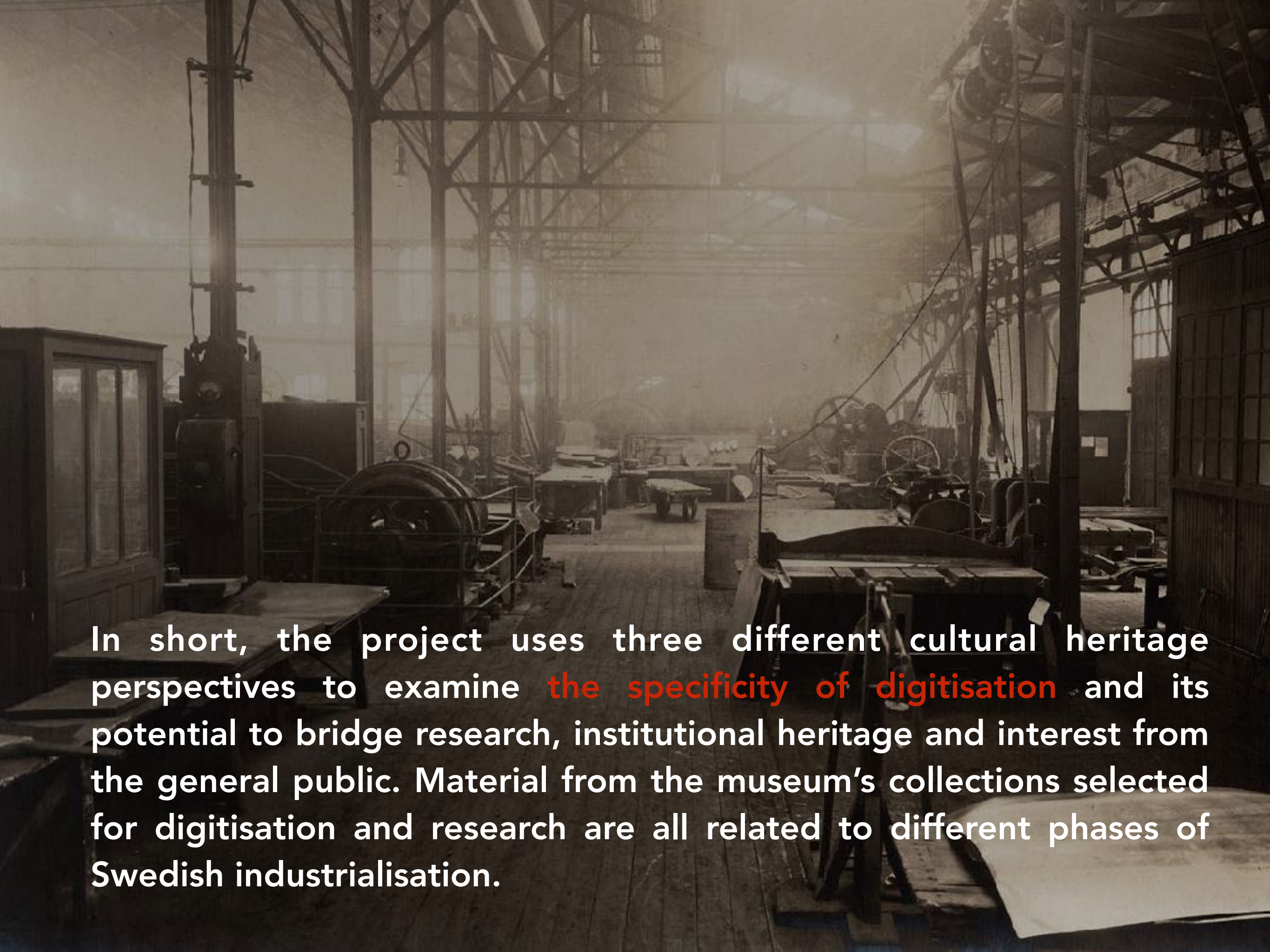

In short, the project uses three different cultural heritage perspectives to examine **the specificity of digitisation** and its potential to bridge research, institutional heritage and interest from the general public. Material from the museum's collections selected for digitisation and research are all related to different phases of Swedish industrialisation.





(A). Parts of the business leader and industry historian, Carl Sahlin's (1861-1943) extensive collection.



(B). All editions of the museum yearbook, *Daedalus* (1931-2014).

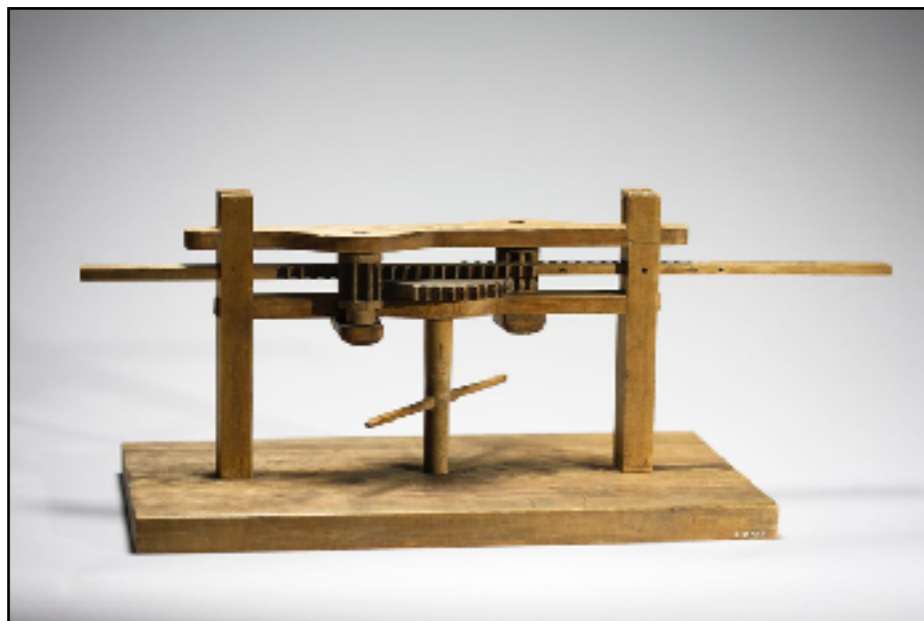

(C). 31 wood models from Swedish pre-industrial inventor Christopher Polhem's mechanical alphabet from the early 1700s.







# Christopher Polhem (1661-1751)





Sahlta Koppar-Grufwa, åt Östra sidan.





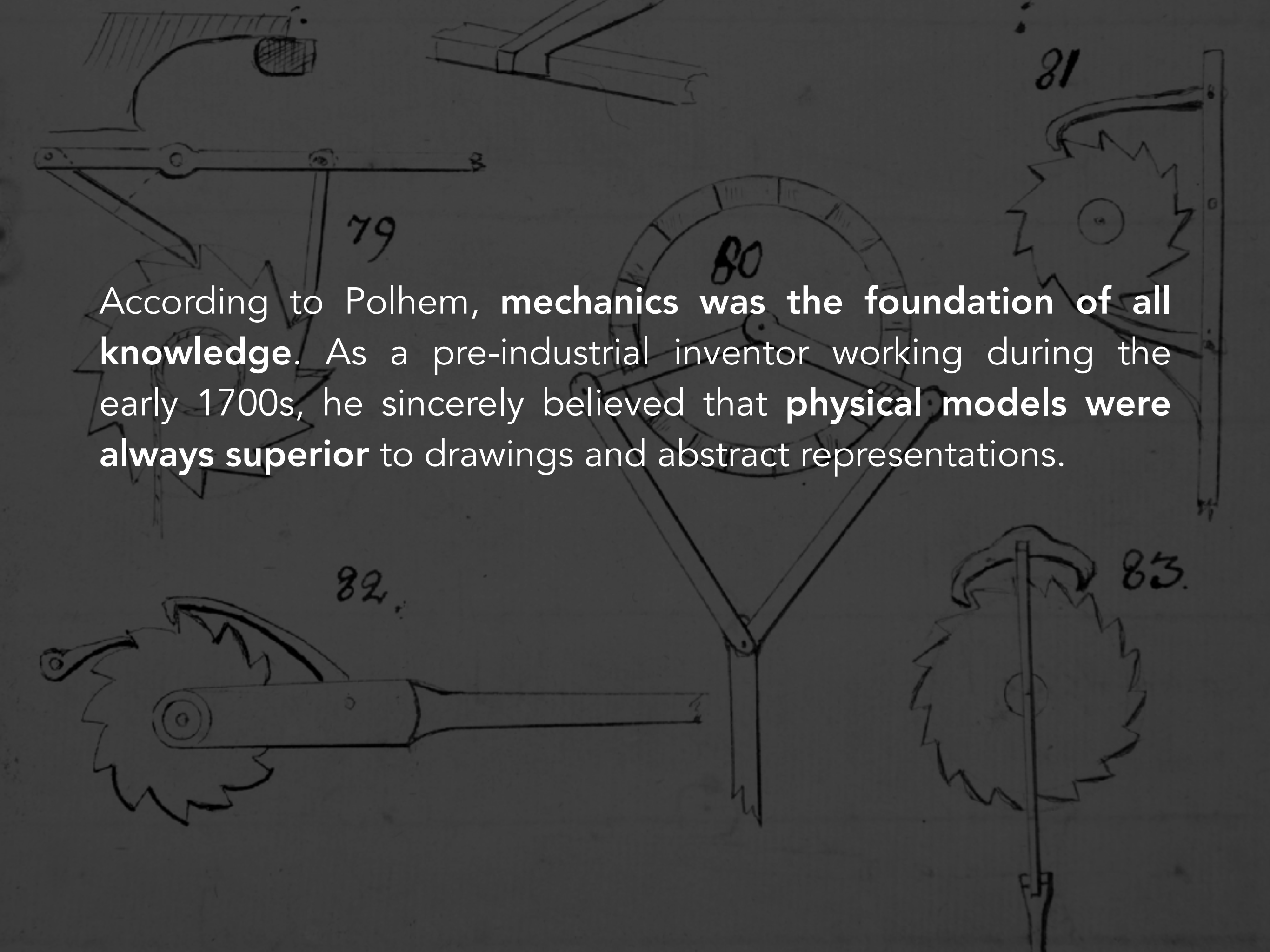

According to Polhem, **mechanics was the foundation of all knowledge**. As a pre-industrial inventor working during the early 1700s, he sincerely believed that **physical models were always superior** to drawings and abstract representations.



Den första Machinen om Ballnings Kraft 3 ätzstellige fall.

N: 1.

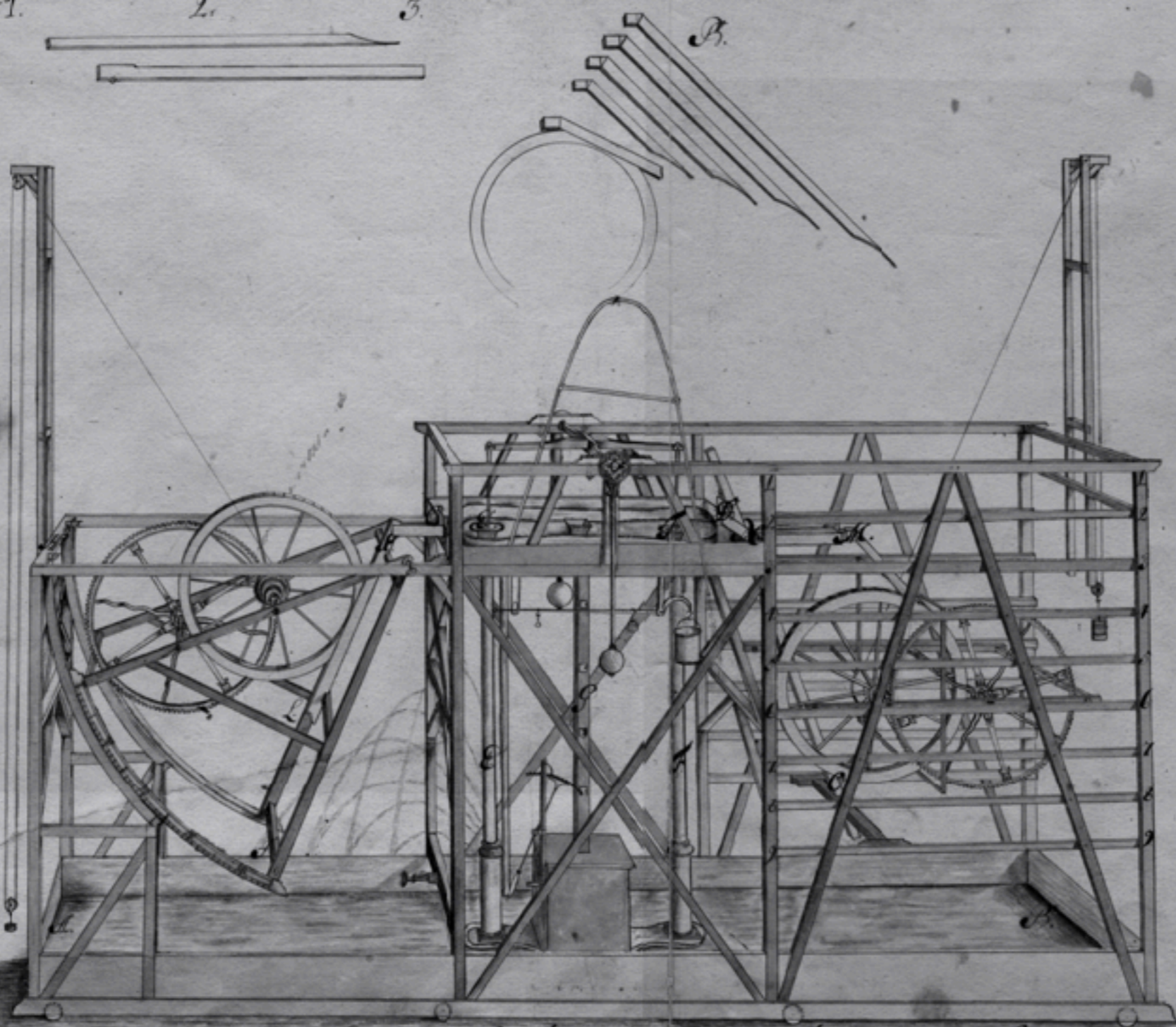
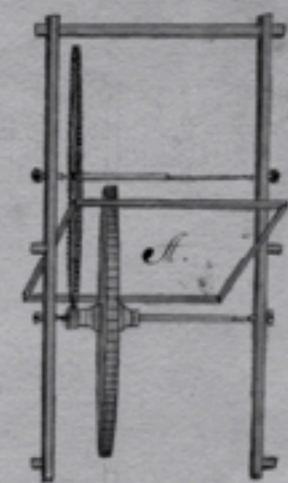
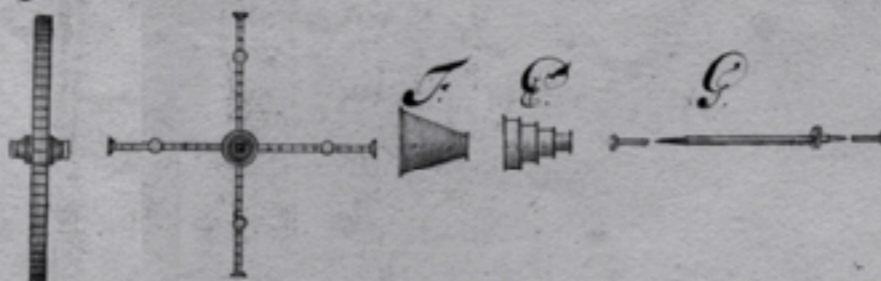
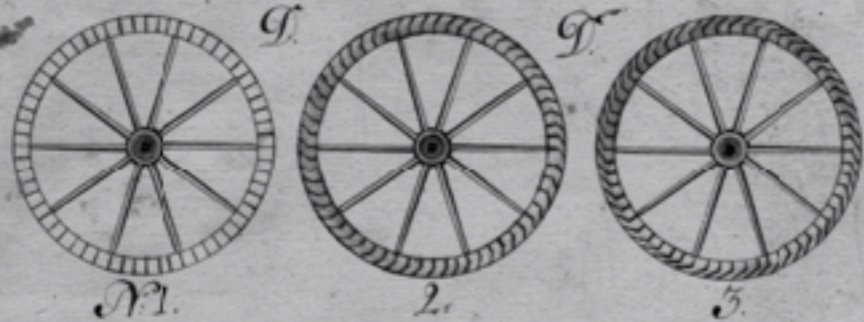

1 toll 2 quarter 1 allnar 2

Christopher Polhem's hydro-dynamic "experimental machine" for water pressure measurements (1705).



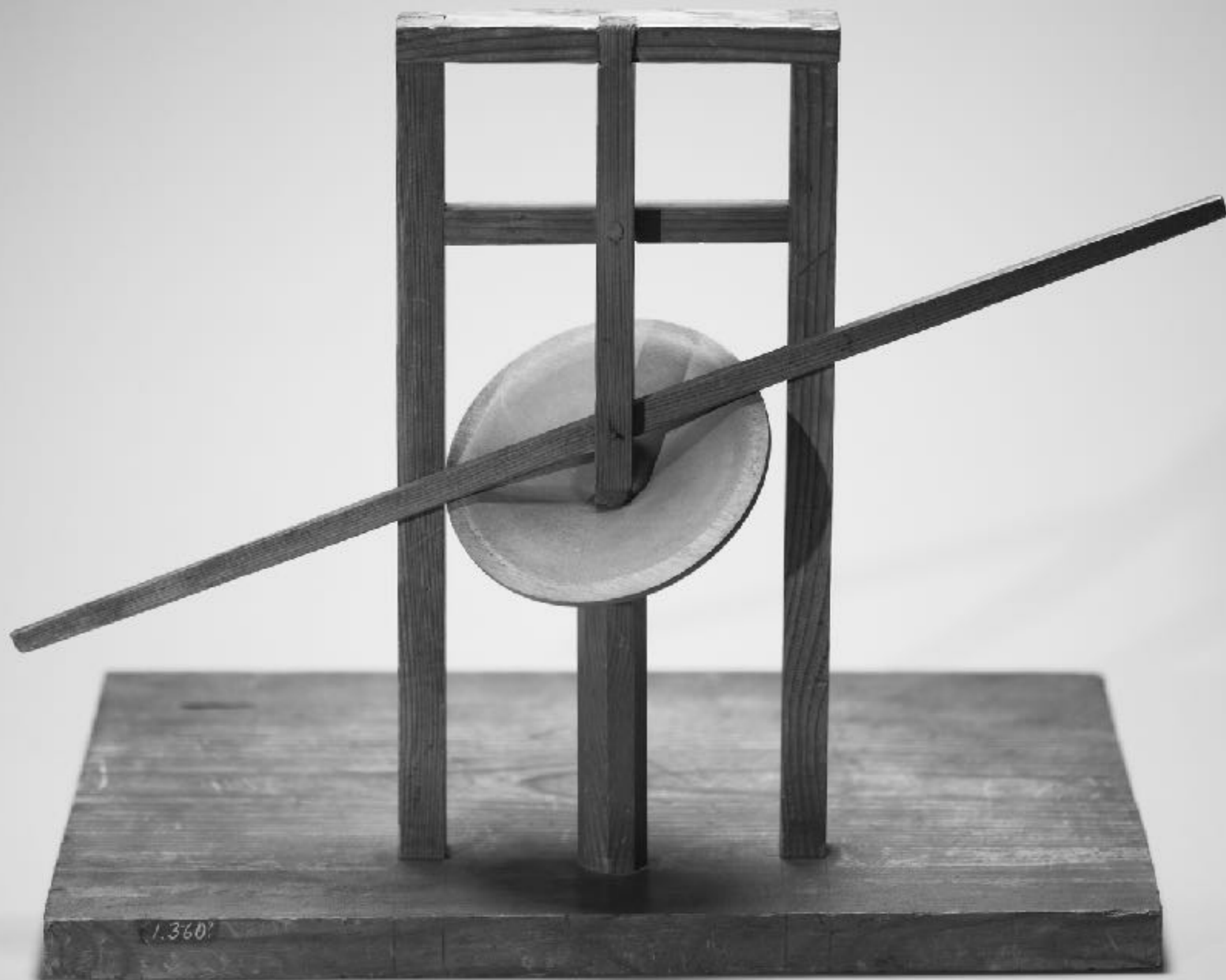



Since a writer naturally had to know the alphabet in order to create words and sentences, Polhem argued that a contemporary mechanicus had to grasp **a similar mechanical alphabet** to be able to construct and understand machines.

This seems to have been Polhem's main **pedagogical idea** for constructing and establishing the **small wooden models** in his so called **mechanical alphabet** in the early 1700s.

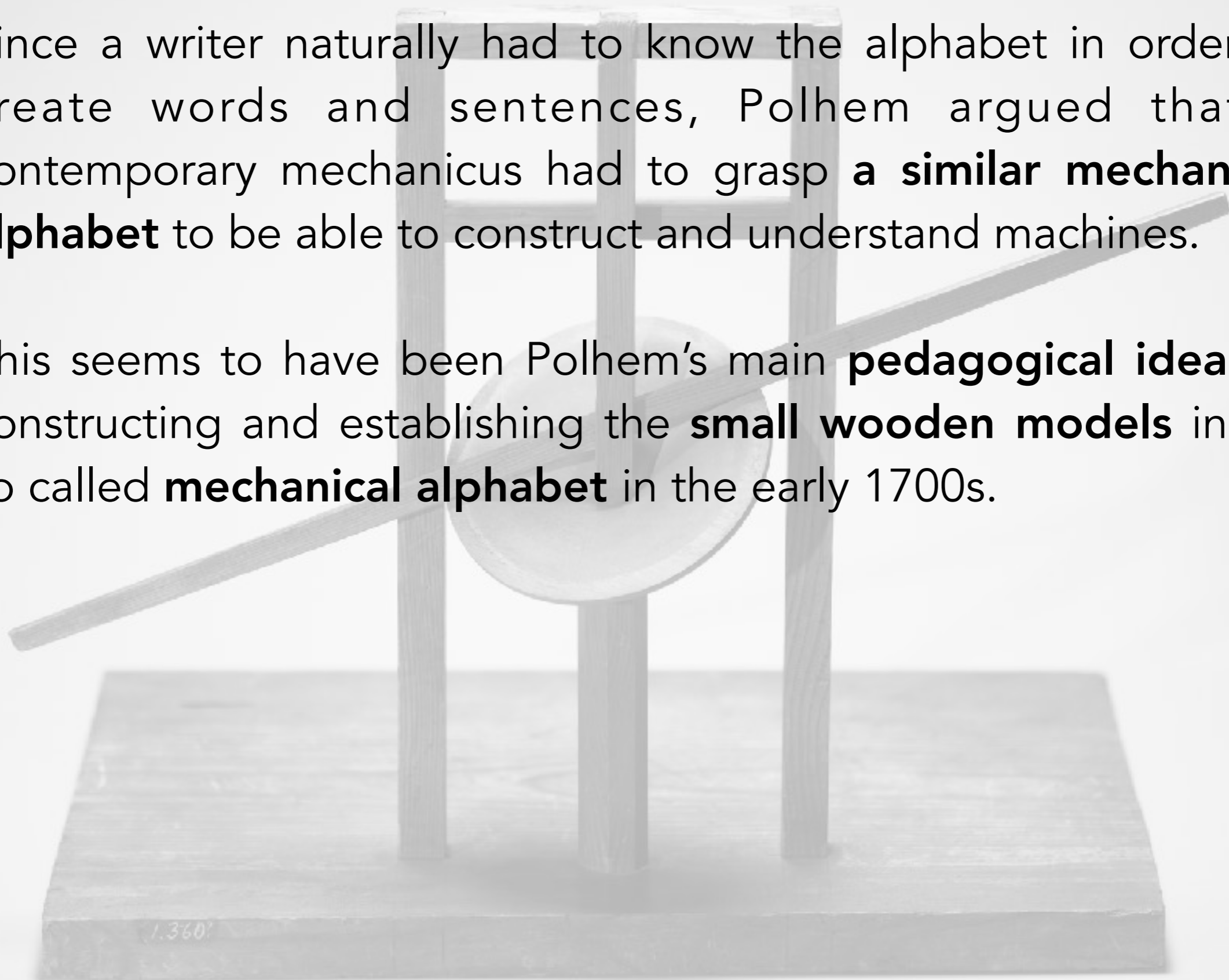



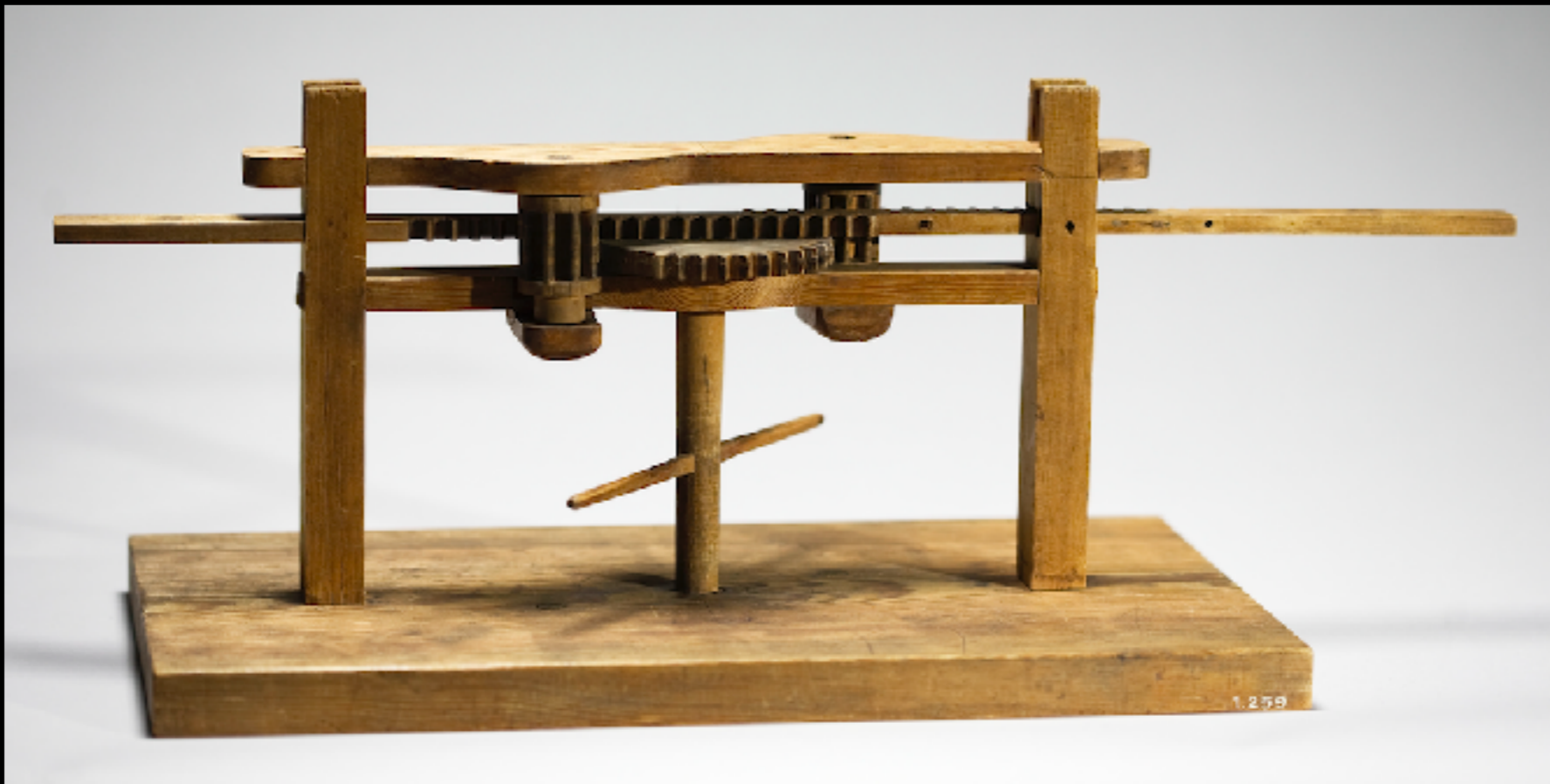

Models from Christopher Polhem's "mechanical alphabet" from the early 1700s. Actual models—whether in the form of originals or copies—can today be found at the Mining Museum in Falun as well as at the Swedish National Museum of Science and Technology in Stockholm.



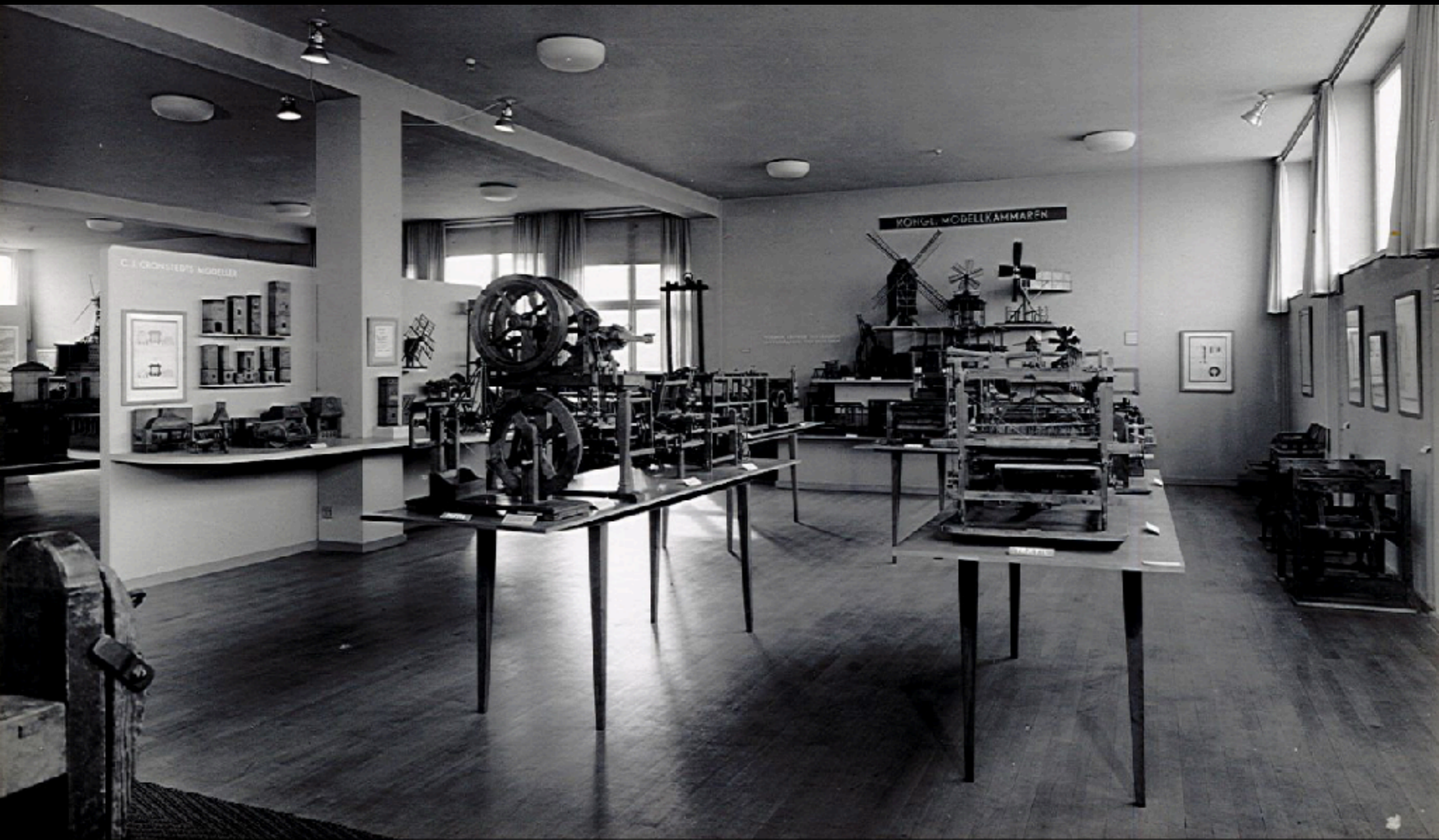

A representation of the Royal Swedish Model Chamber (with some original models) displayed at the Swedish National Museum of Science and Technology in 1947.



Swedish historians of science, however, have had a hard time to figure out **exactly what kind of letters**—or sentences—that Polhem's alphabet actually referred to.

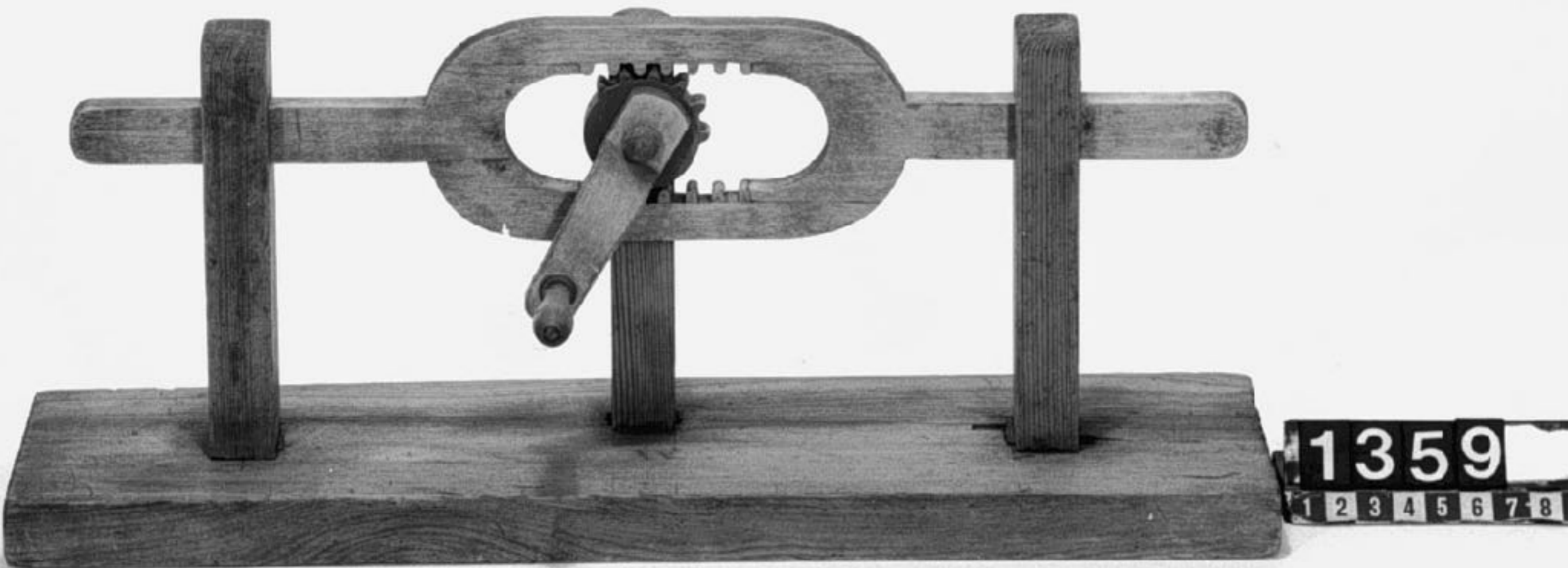



Then again, the small models' physical concreteness and enigmatic character did contribute to the fame of the collection.

Hence, in more than one way, Polhem's alphabet is indeed "the coming into being of **scientific objects**" (Lorraine Daston). The **cultural biographies** of these models indeed display a fascinating history.

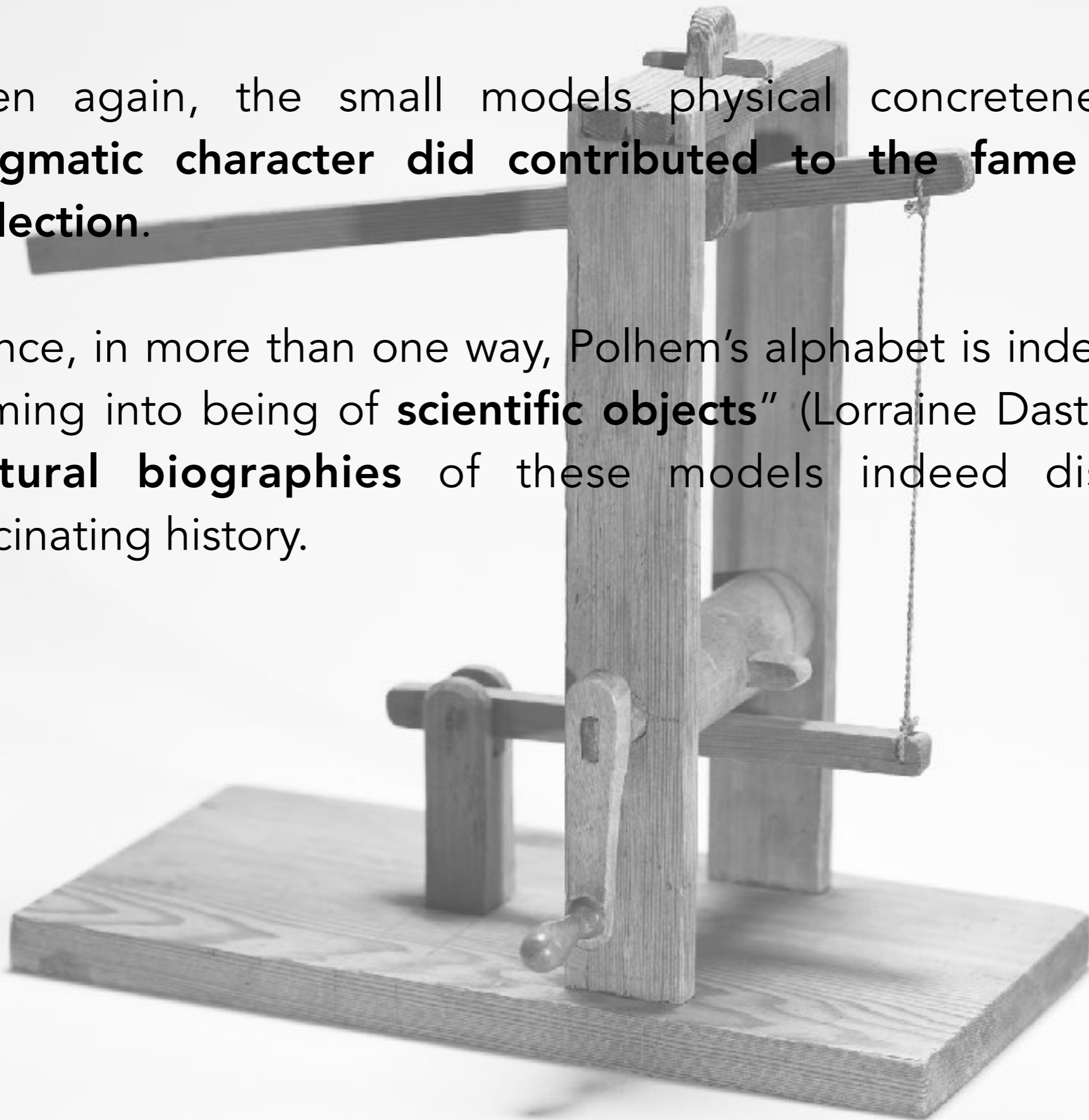



... a short model biography ...





TAL  
OM  
NYTTAN  
AF ET  
*Laboratorium Mechanicum,*  
HÅLLIT FÖR  
KONGL. VETENSKAPS ACADEMIEN  
AF  
CARL KNUTBERG,  
CAPITAINE MECHANICUS,  
DÅ HAN DER BLEF SÅSOM LEDA-  
MOT INTAGEN  
DEN 16 NOVEMBER 1754.



På Kongl. Vetenskaps Academiens befallning.

STOCKHOLM,  
Tryckt hos LARS SALVIUS, 1754.

INVENTARIUM  
ÖFVER DE  
MACHINER  
OCH  
MODELLER,  
SOM FINNAS  
VID  
KONGL. MODELL-KAMMAREN  
I STOCKHOLM,  
BELÅGEN UTI GAMLA KONGSHUSET  
PÅ  
K. RIDDAREHOLMEN.



STOCKHOLM,  
TRYCKT HOS ANDERS J. NORDSTRÖM. 1779.

Book frontispieces of Carl Knutberg's, *Tal om nyttan af et laboratorium mechanicum, hållit för kongl. vetenskaps academiem* (Stockholm, 1754), as well as the inventory (of models and machines) at the Royal Swedish Model Chamber in 1779 (compiled by Jonas Nordberg), *Inventarium öfver de machiner och modeller, som finnas vid kongl. modell-kammaren i Stockholm, belägen uti gamla kongshuset på k. Riddareholmen* (Stockholm, 1779).













SVENSKA SOCKERFABRIKS ABTEDELINGEN

BITSOCKER

SVENSKA SOCKERFABRIKS ABTEDELINGEN

BITSOCKER

B

Handwritten text on a box, possibly "Svenska Sockerfabriken"



# HITTILLS OKÄNDA POLHEMSMASKINER FUNNNA I STOCKHOLM.

Tekniska högskolan deponerar åttahundra maskinmodeller i Tekniska museet.





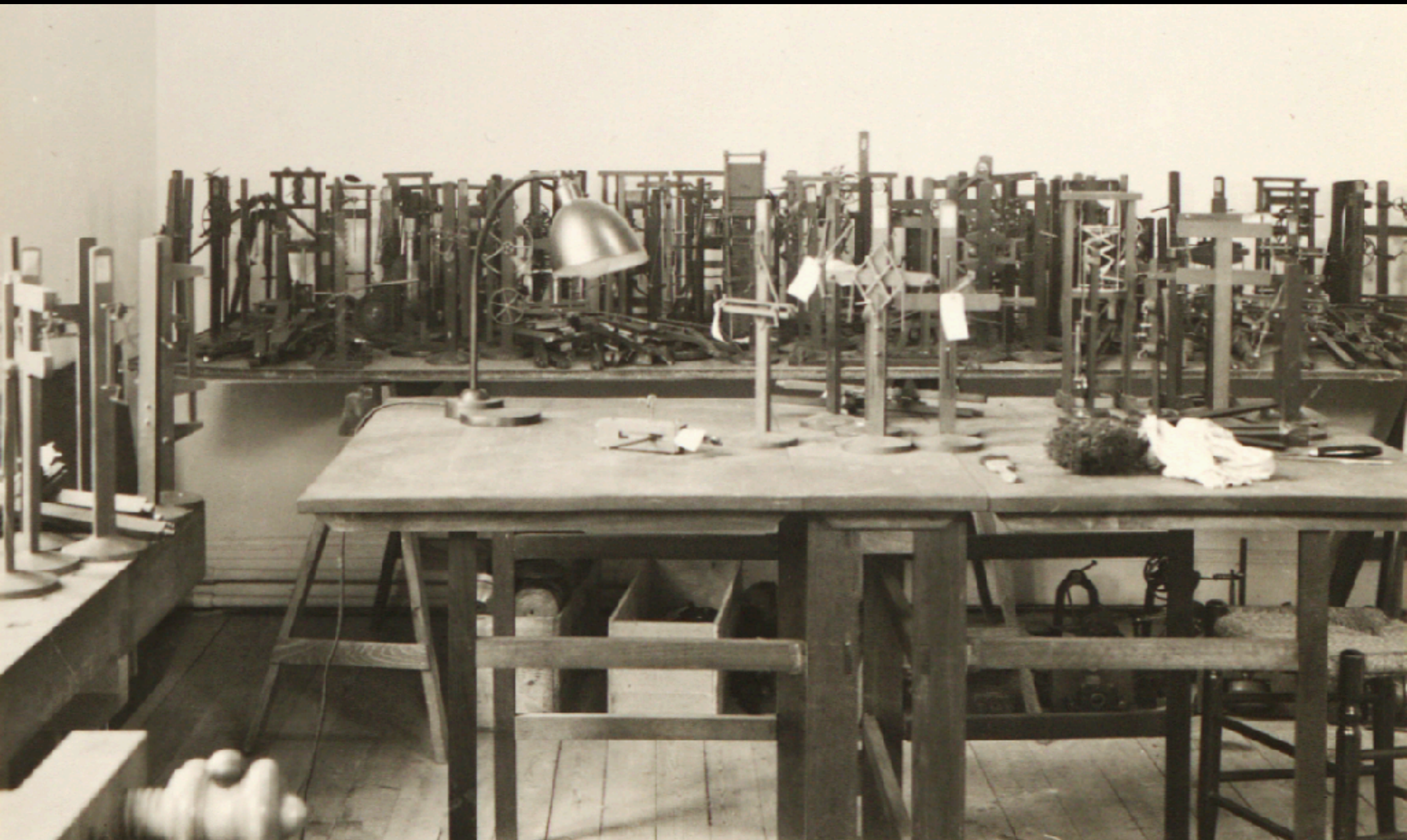



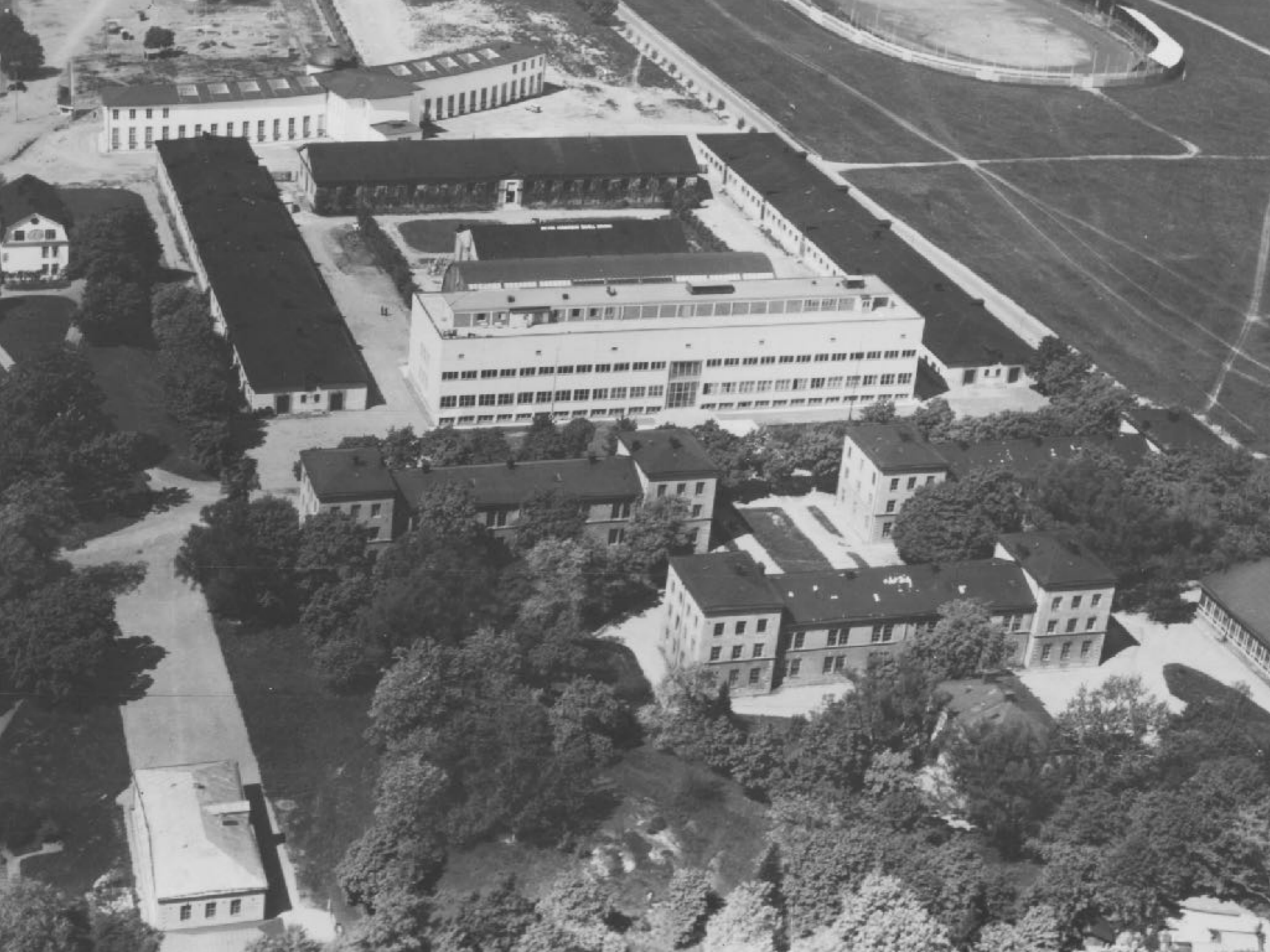



POLHEMS MEKANISKA ALFABET



POLHEMS MEKANISKA ALFABET





Essentially, Polhem's models have been exhibited as a kind of **meta-museological artifacts**.

In a museological context their pedagogical quality gained a new meaning—from **actual technological principles to historically situated mechanics**. "Biographies of things can make salient what might otherwise remain obscure" (Igor Kopytoff).

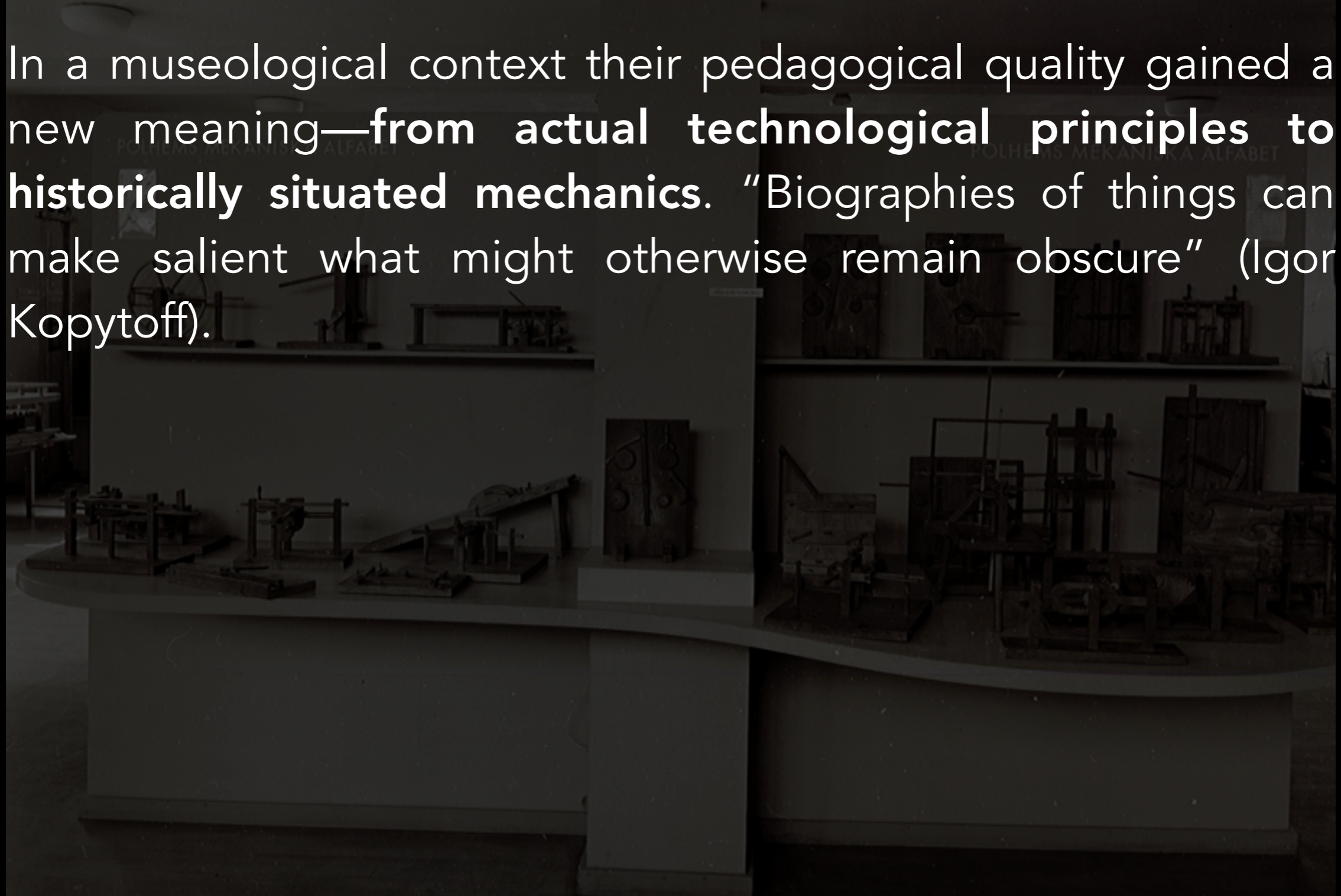



# 3D Metamodeling

In order to investigate **the specificity of three-dimensional scanning, rendering and modeling**, we decided **to apply five different forms of 3D visualisations** of Polhem's alphabet—executed in **altered media modalities**.



## I. Stupid Scanning

We used an ordinary iPhone—and the Agisoft Photoscan software—to repeatedly photograph one of Polhem's models.



Senaste import

150 bilder





**123D Catch is a free app that lets you create 3D scans of virtually any object.**

Available on:





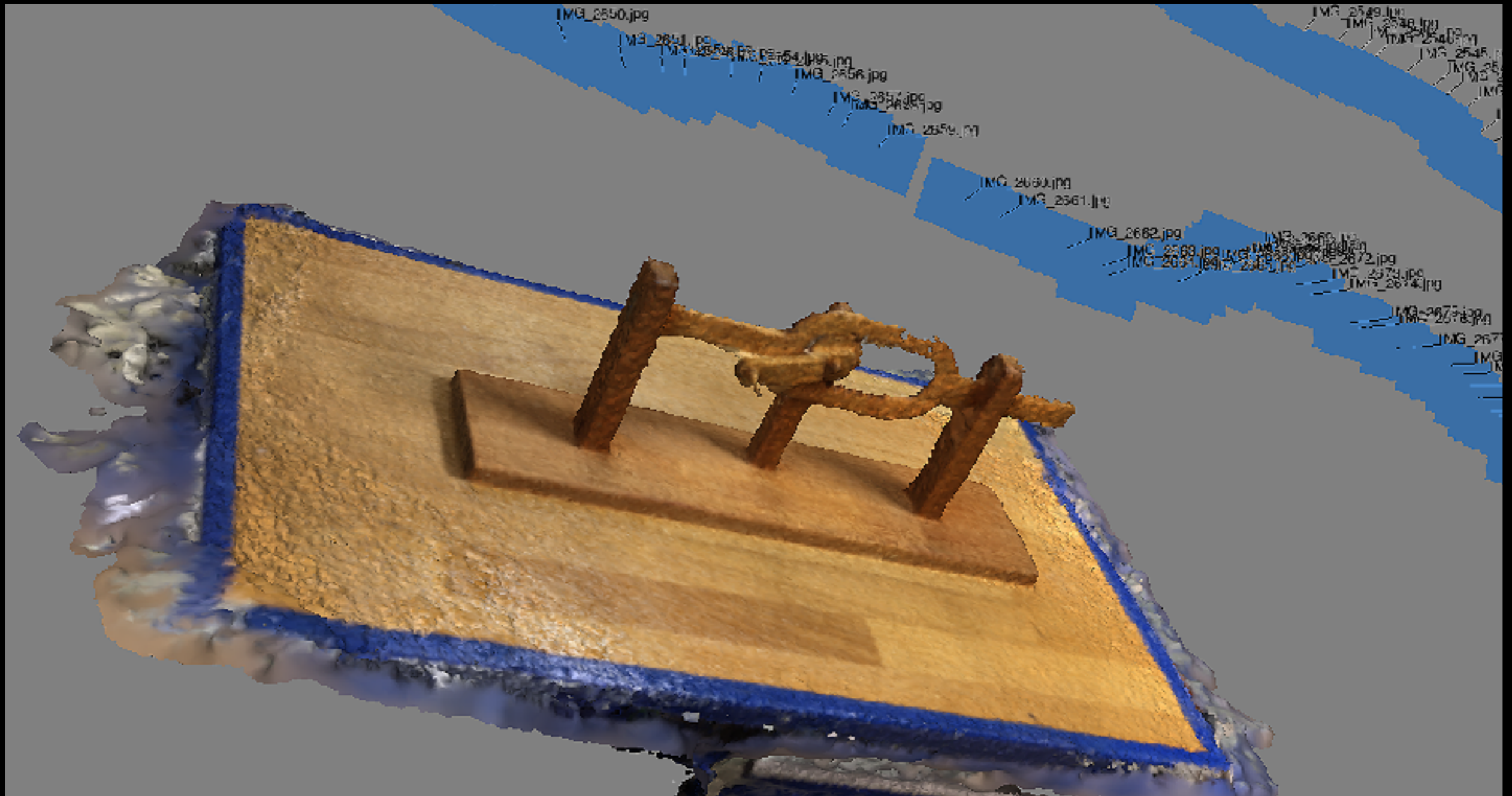

Simple scanning of one wooden model from Polhem's mechanical alphabet—using an iPhone and the software Agisoft Photoscan yet with no post processing. The IMG.jpg-markers indicate where photographs were taken.



## II. Computer Animated Models

We collaborated with the professional Swedish animator Rolf Lindberg who computer-animated some models (rather than scanning them).



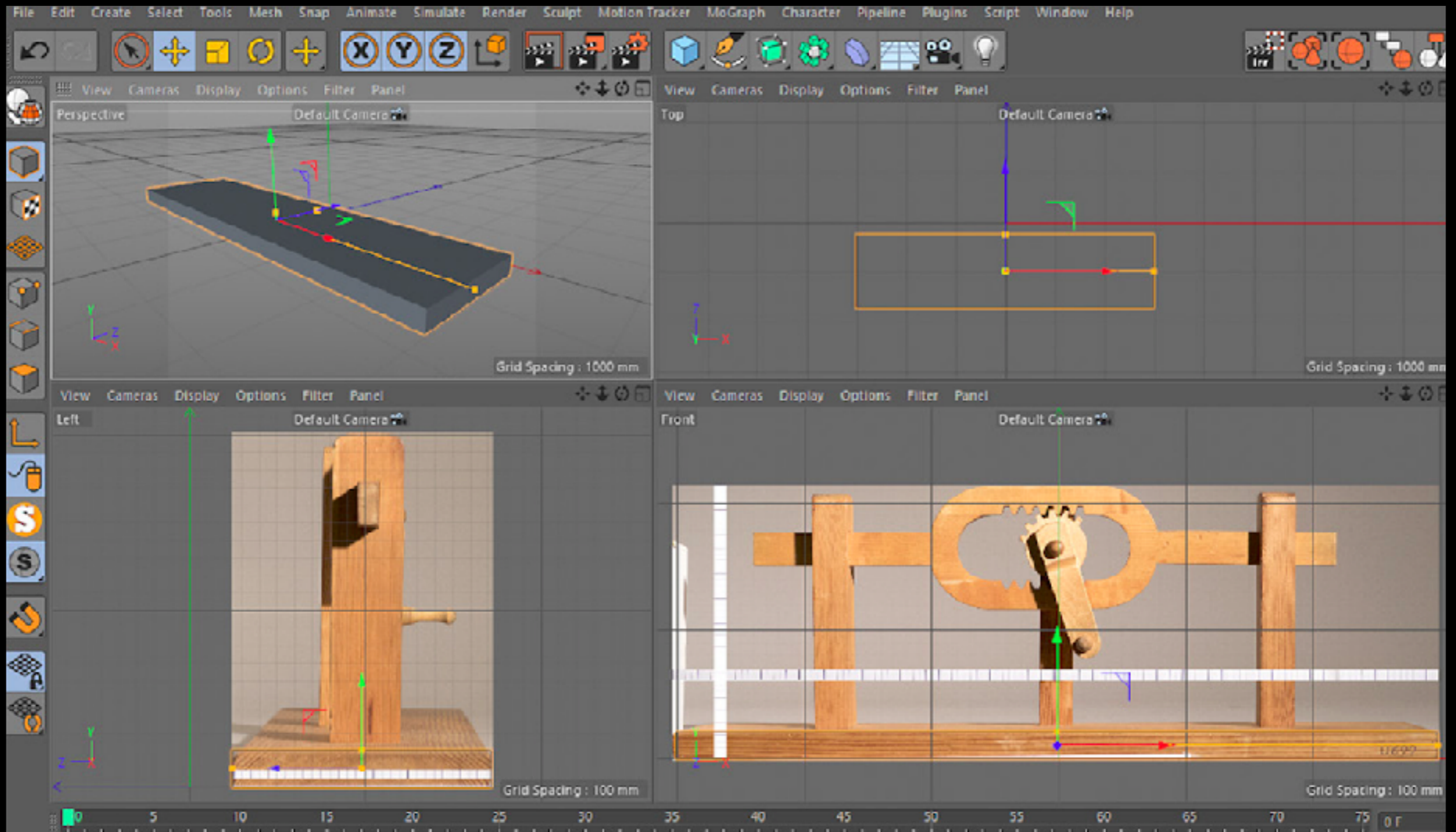

Rolf Lindberg simulated a model from Polhem's mechanical alphabet—by way of a few photographs—and constructed a brand new virtual object in the software Cinema 4D.



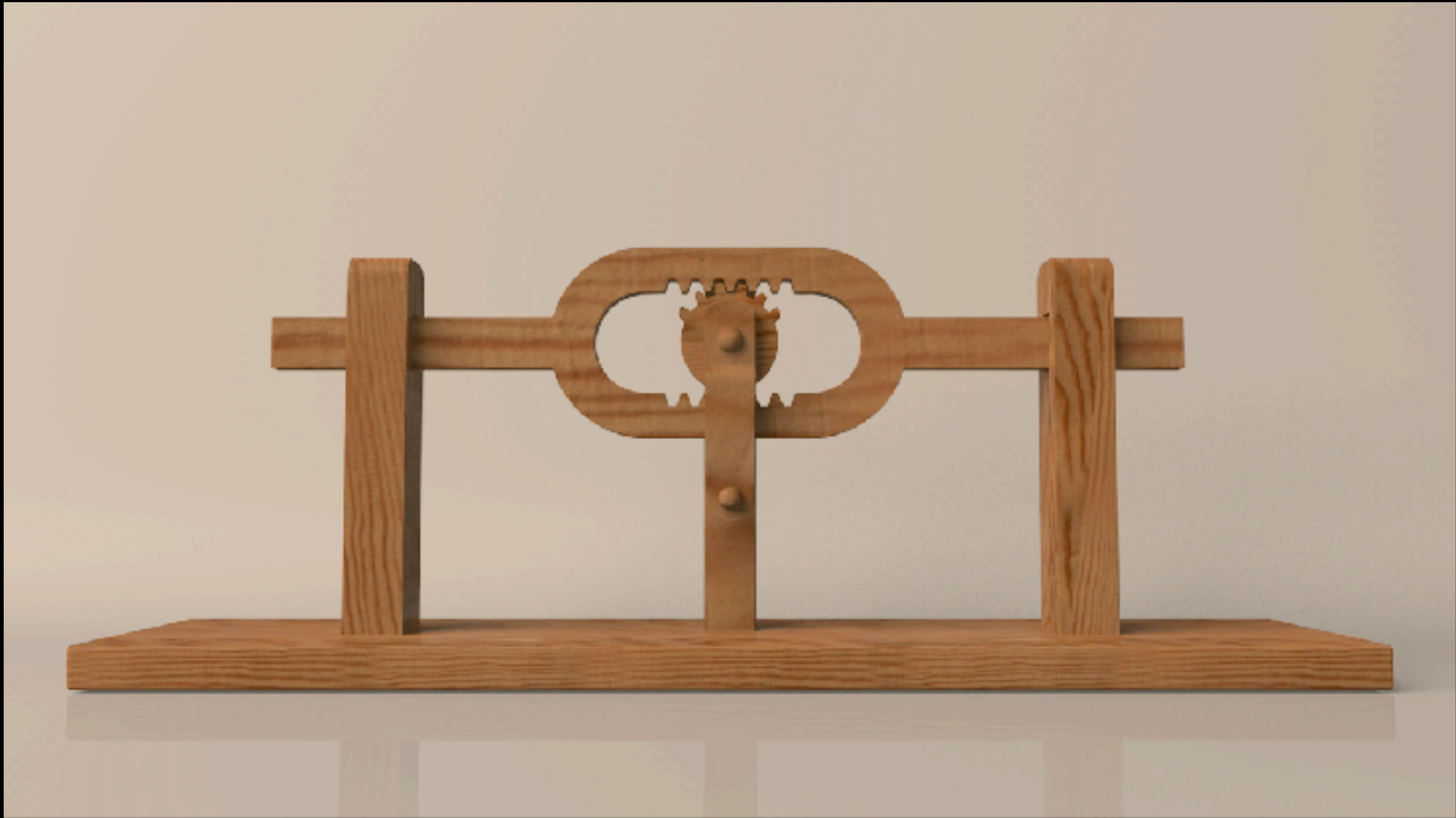
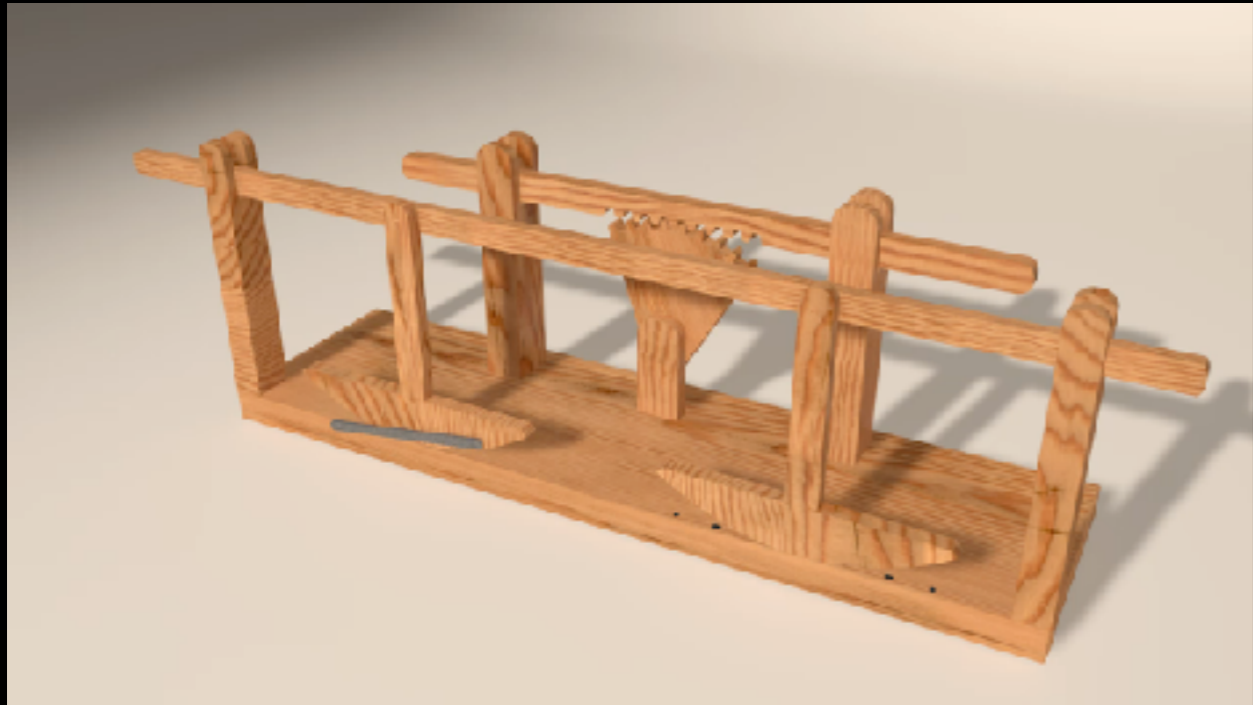



### III. CT-Scanning Models

We CT-scanned some models at Linköping University Hospital in a collaboration with the Center for Medical Image Science and Visualization.



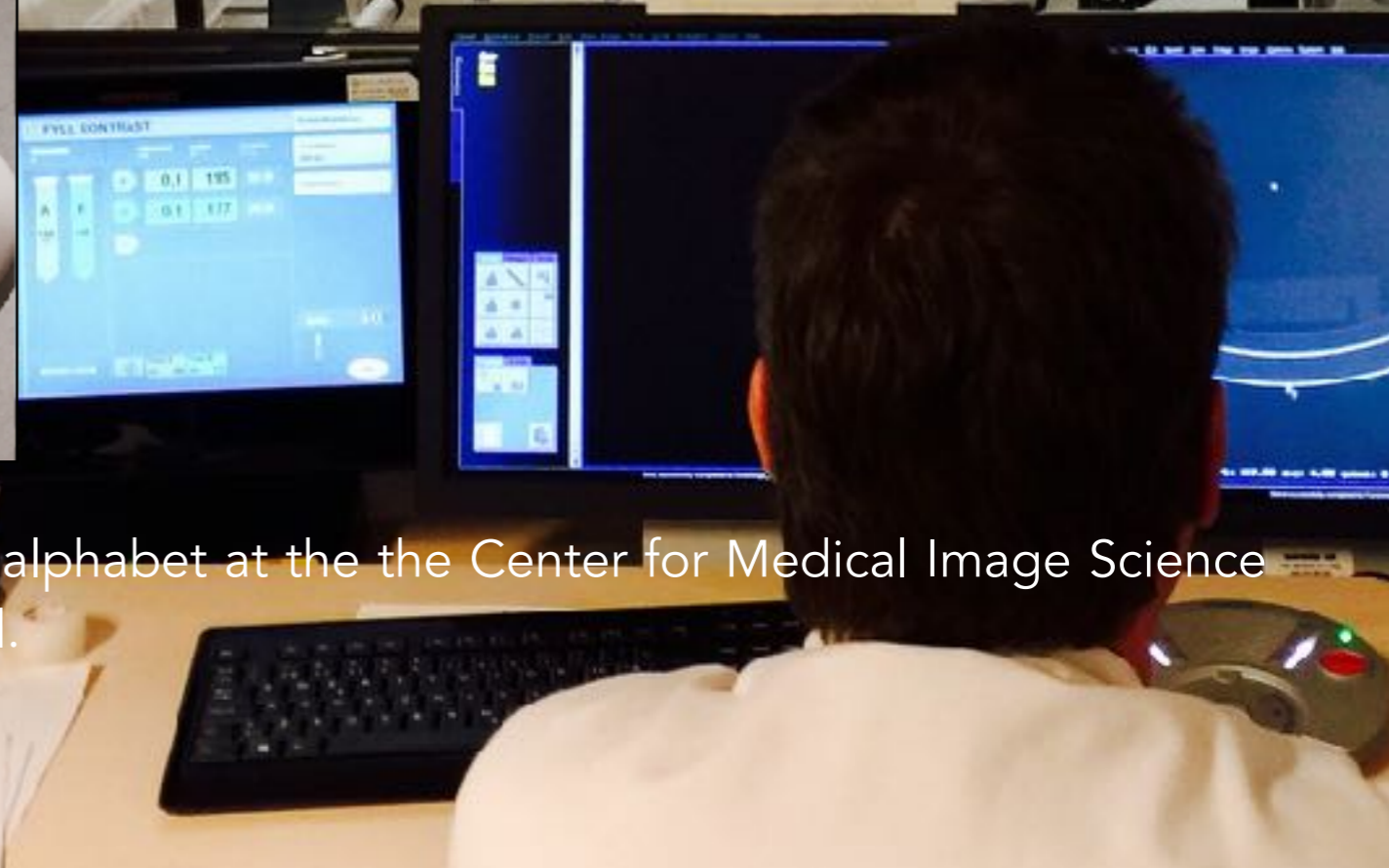
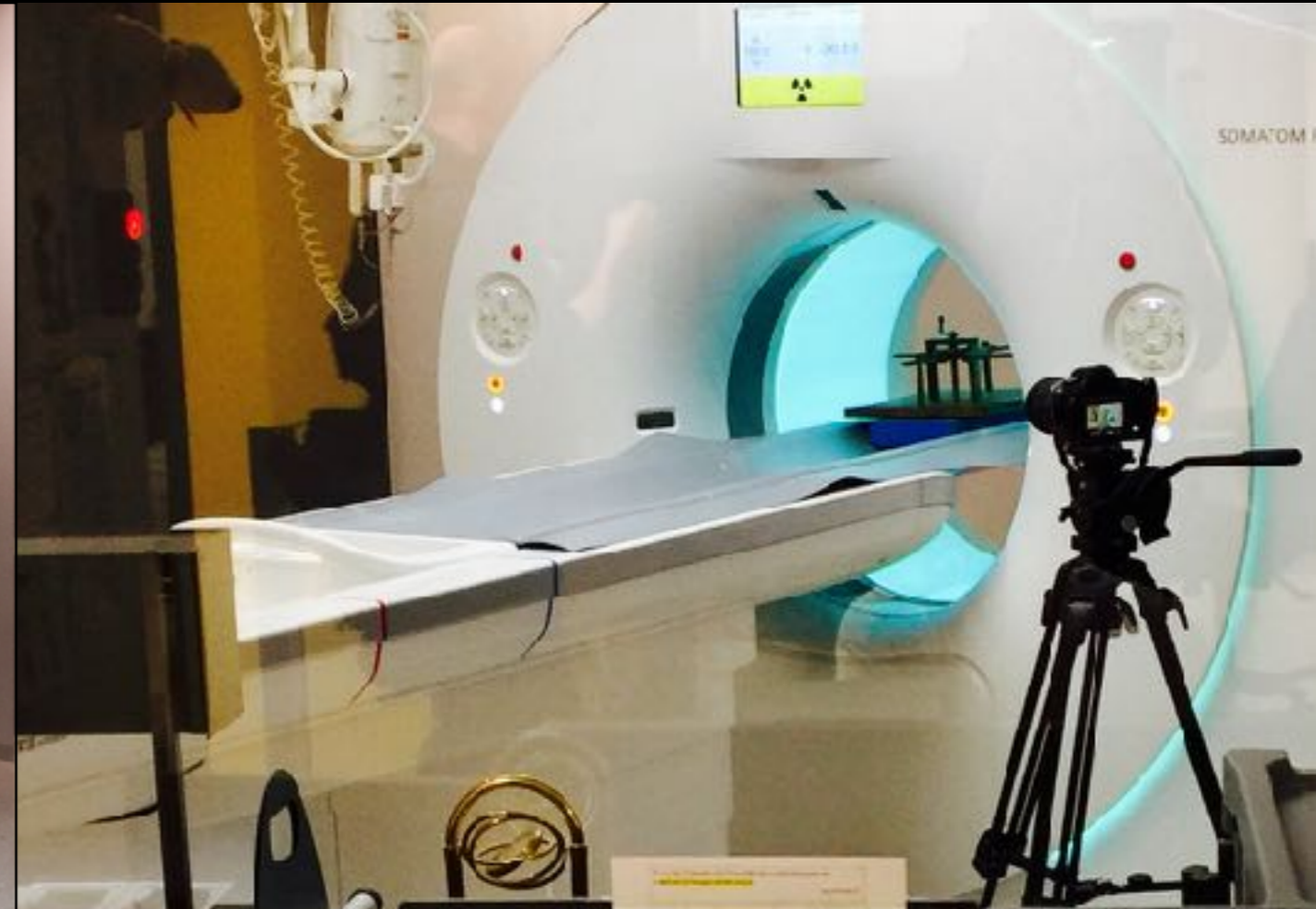

CT-scanning a model from Polhem's mechanical alphabet at the the Center for Medical Image Science and Visualization at Linköping University Hospital.



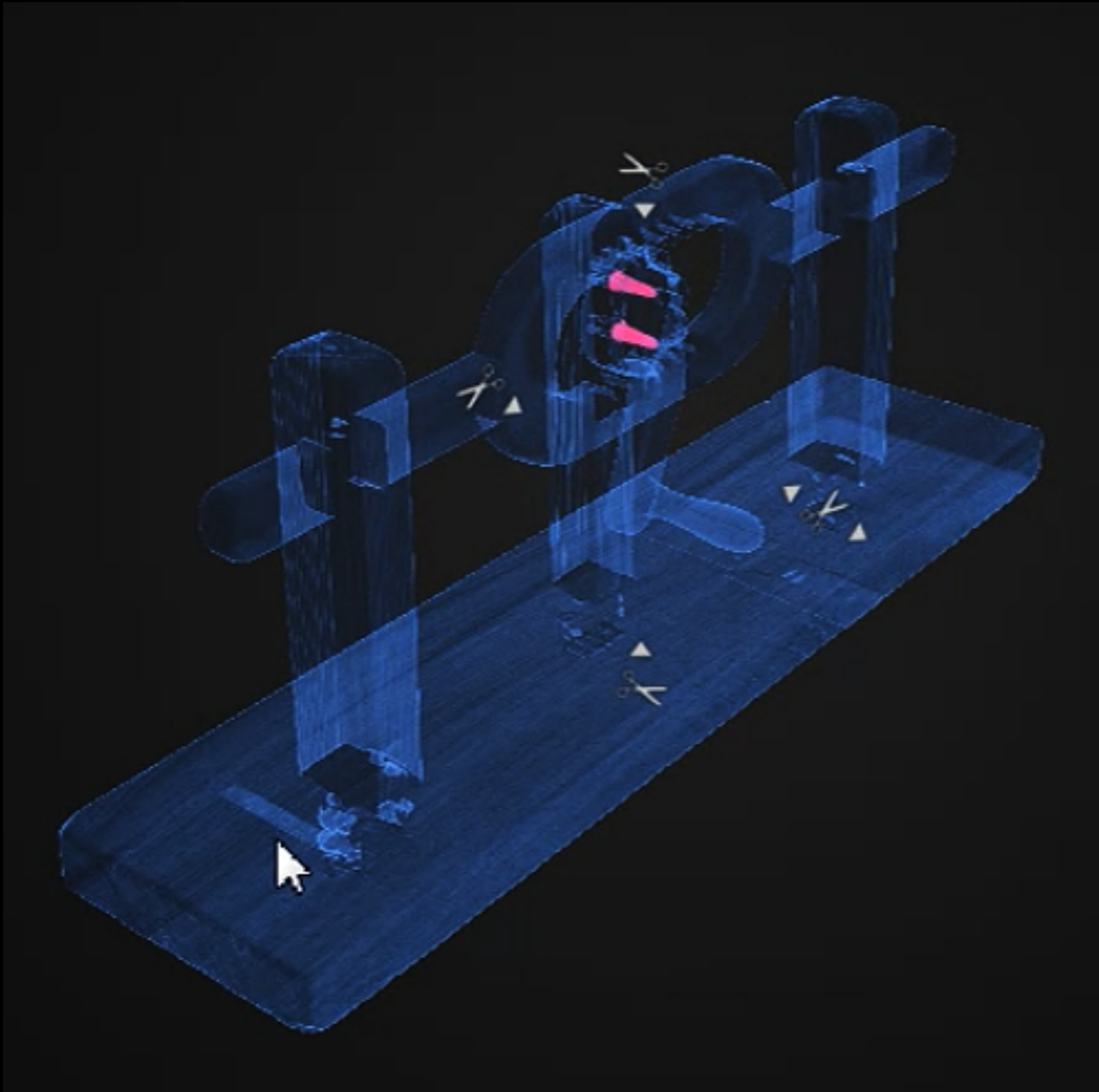

Inside Polhem—CT-scanning a model in collaboration with the company **Interspectral** made it possible **to see inside models** without breaking them.



1359

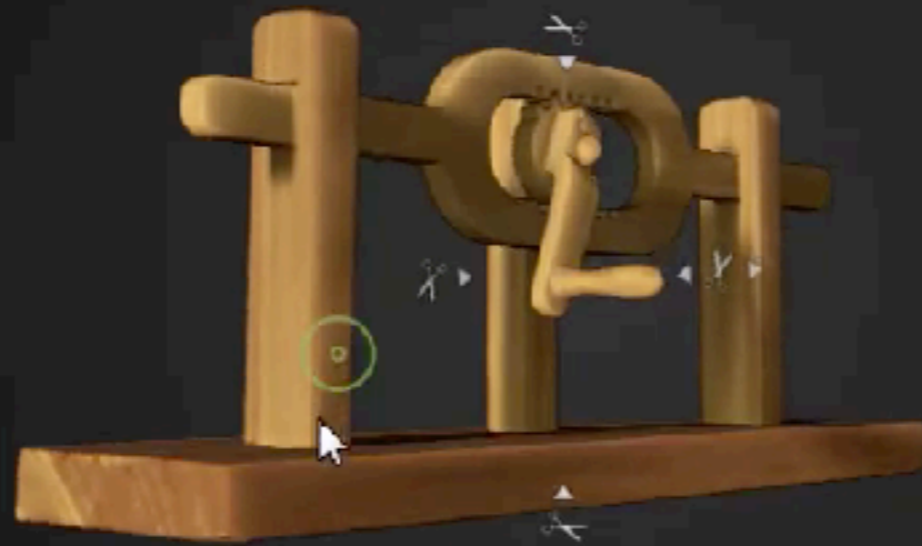

Solid Wood

Shell & Metal





## IV. Student Scanning

We collaborated with two students, **Kevin Karlsson and Fredrik Olsson**—training to become 3D technicians—who used **photogrammetry to make 3D visualisations of all models.**



# Student photogrammetry

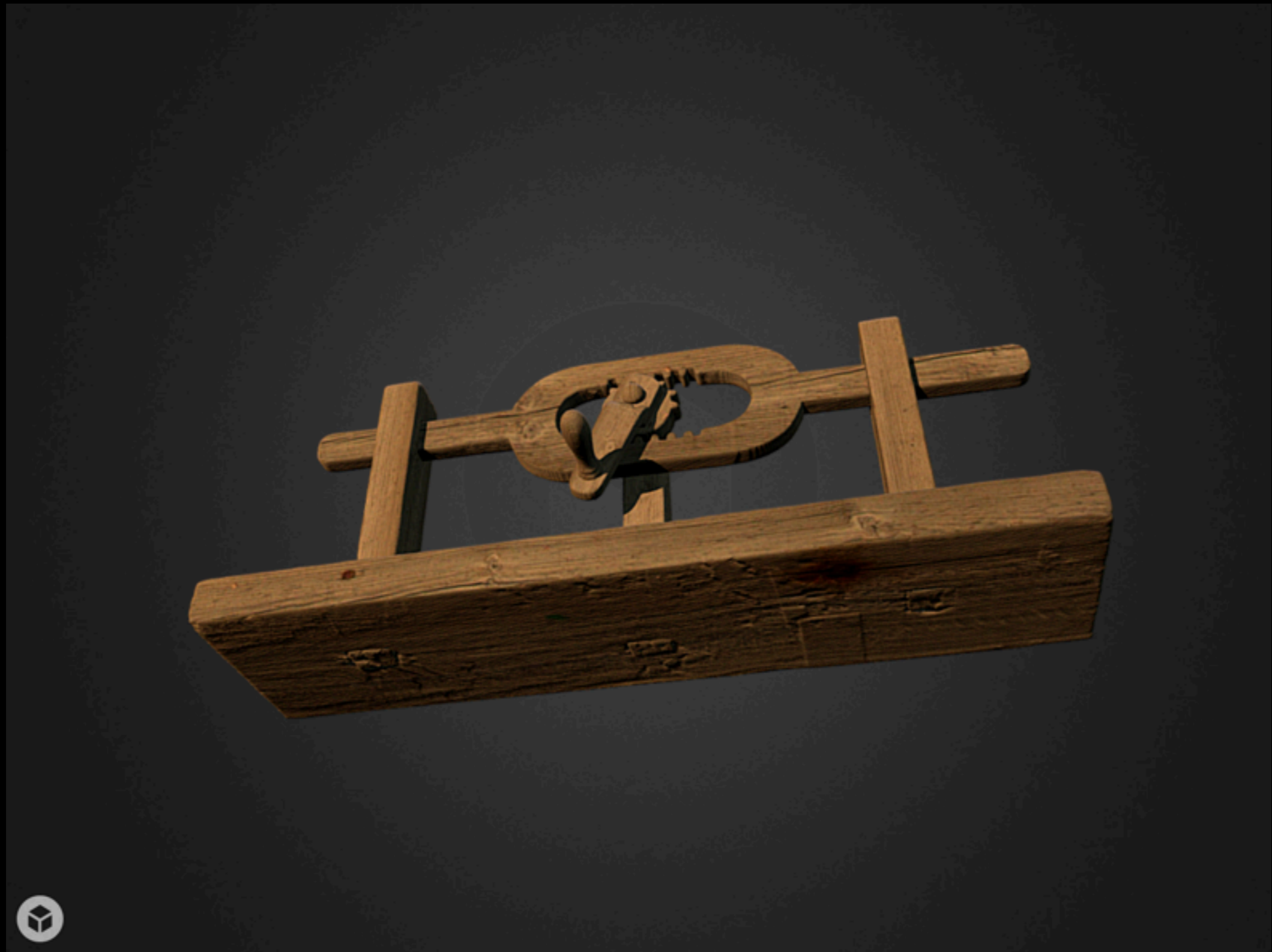



## V. Remodeling the Swedish Model Chamber in VR

At Umeå University we **re-modelled Polhem's mechanical alphabet by building a virtual reality model**—for HTC Vive glasses with the software Unity—of the **Royal Swedish Model Chamber around 1760.**

Trough the CT-scans we were able **to separate individual parts of models for reconstruction**—and in VR we thus inserted some of our differently digitised models.



# VR simulation beta

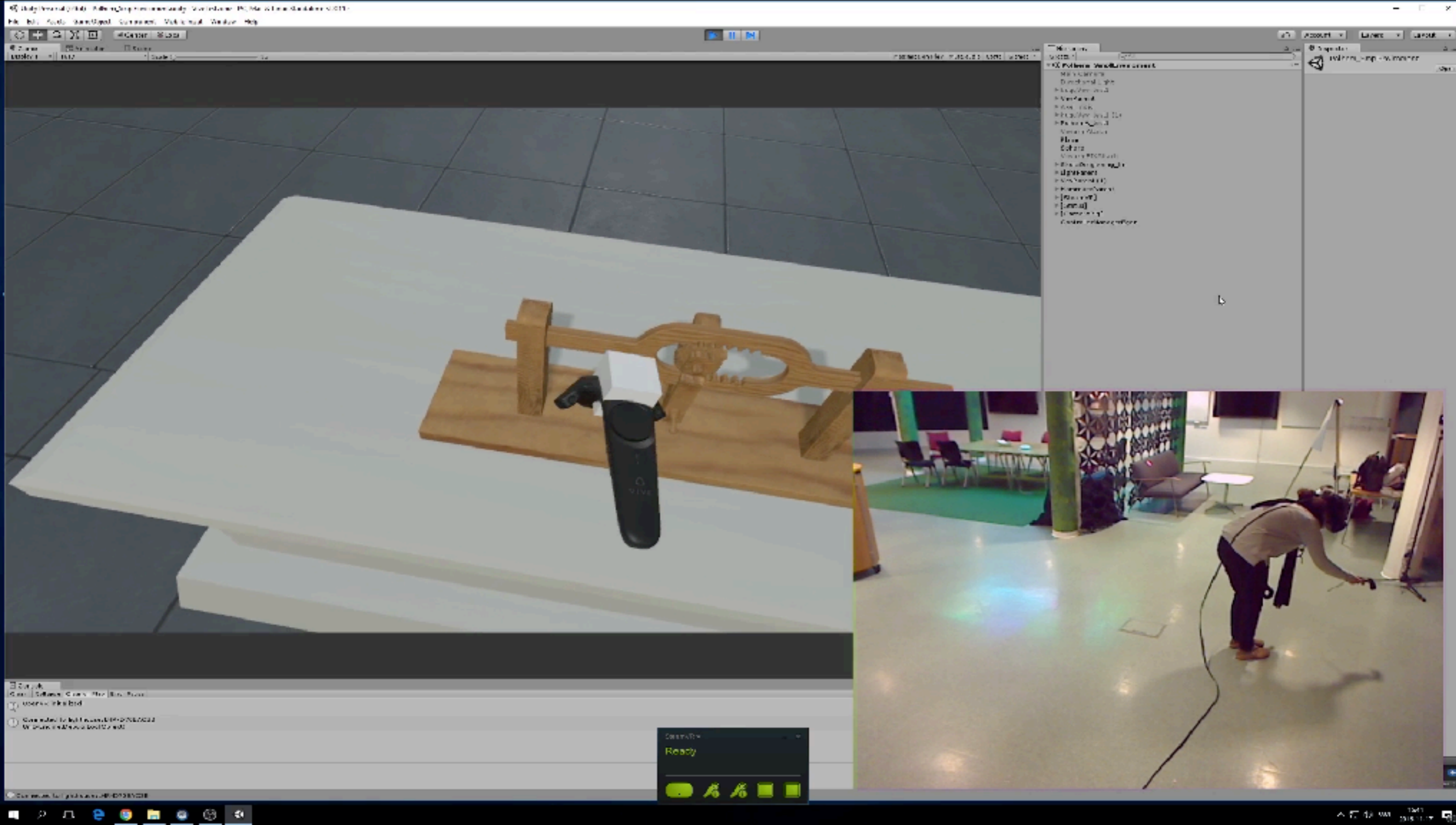



2D Debug





# To Conclude—3D Metamodeling

## To Conclude—3D Metamodeling

Essentially, the purpose of these try-outs of multiple scanning procedures—or perhaps models of models—was **to raise awareness within the heritage domain** that 3D digitisation and visualisations can be done in various ways.



## To Conclude—3D Metamodeling

Using Polhem's mechanical alphabet as a case different 3D digitisation methods will result in **representations that share some attributes with the original models**—but not all of them.

The difficulty in rendering Polhem's models based on "technical rigour in digital heritage visualisation"—to quote the London charter on 3D heritage—became especially problematic regarding animations of **model movement**.

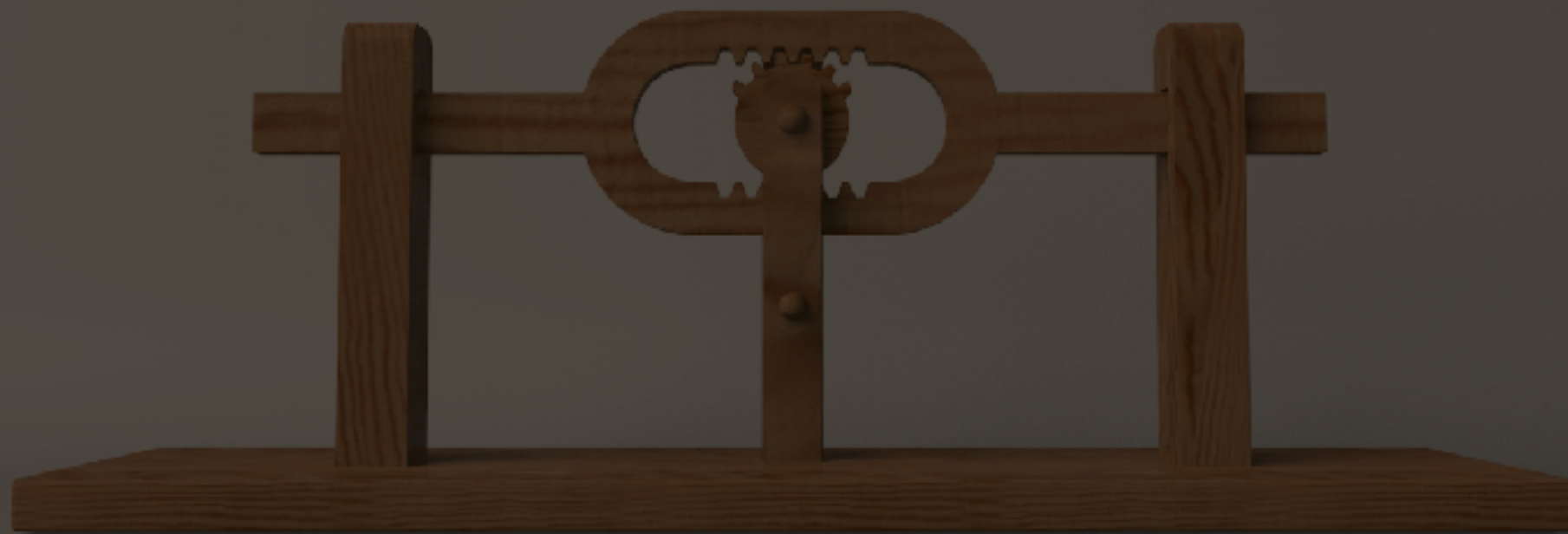



## 3D Metamodeling **Movement**

You can, for example, **move a 3D model around—but not move its parts**. In an animation, on the other hand, all parts move—but you **cannot steer movement yourself**. In **virtual reality you can do both—but** at the expense of transporting yourself to nowhere.

## 3D Metamodeling **Friction**

Friction was another matter related to movement. Naturally, **computer code** could make the cogwheel, for example (in one of the models), run completely smooth. In the original model, however, **the cogwheel caused a lot of friction; the model was built by wood after all.**

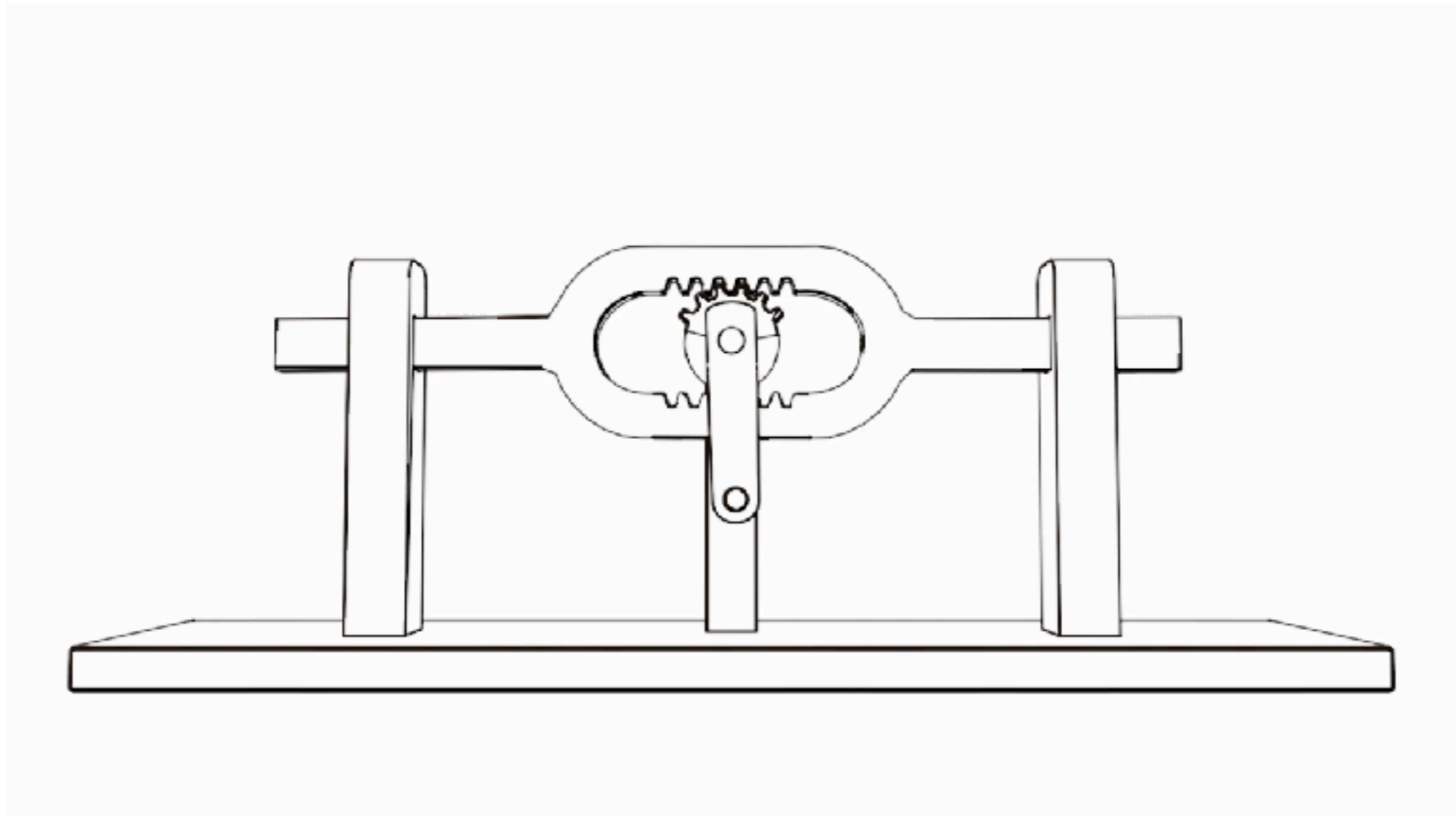



We asked animator Rolf Lindberg **to make friction more noticeable** when the cogwheel moved (which he did), and similarly in other animations too. In fact, the tricky issue of how to represent friction in a technical rigours way in 3D, became an interesting research question for us, and we also tried to insert various forms of frictions in our virtual reality model.

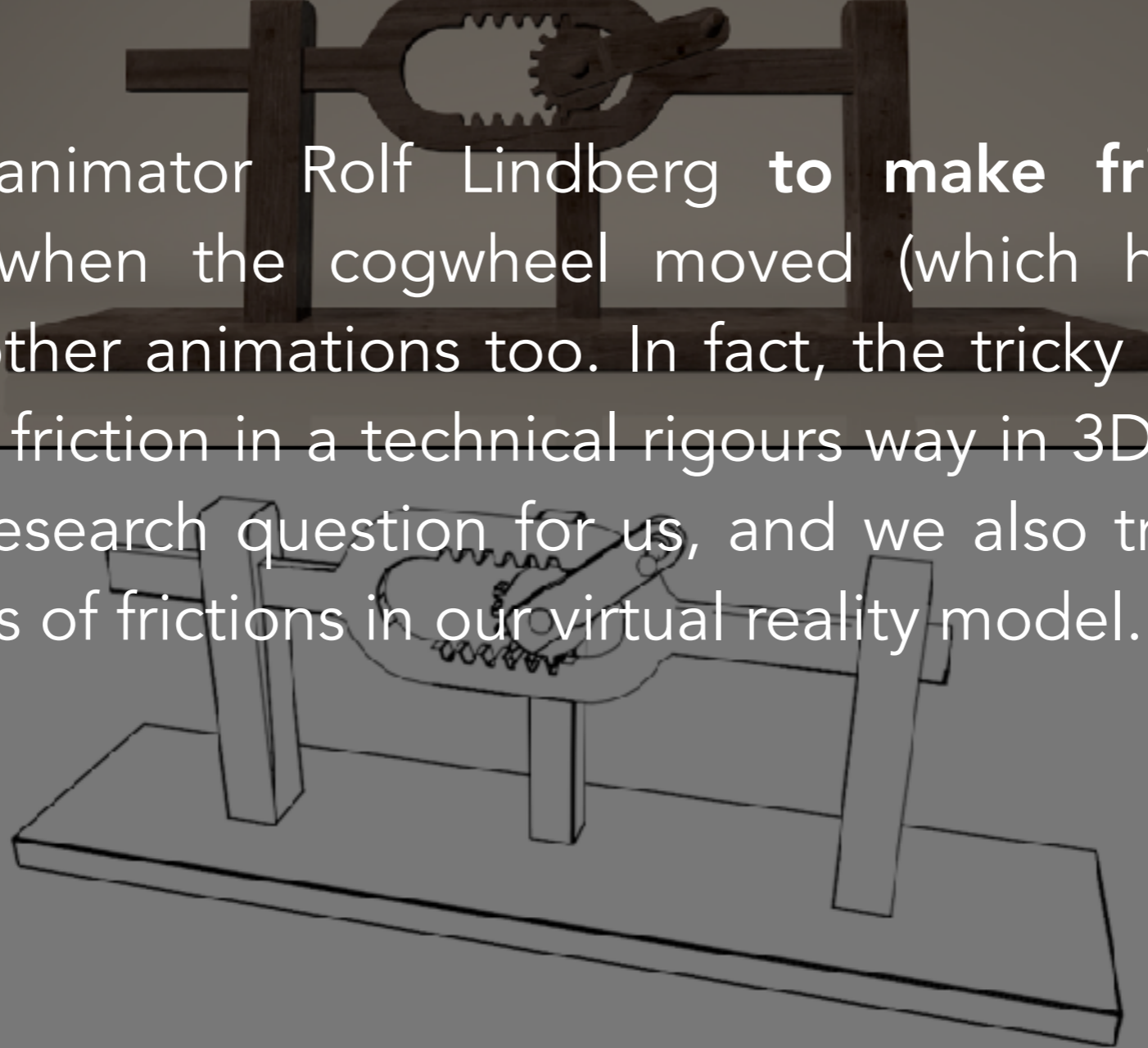

# 3D Metamodeling **Friction**

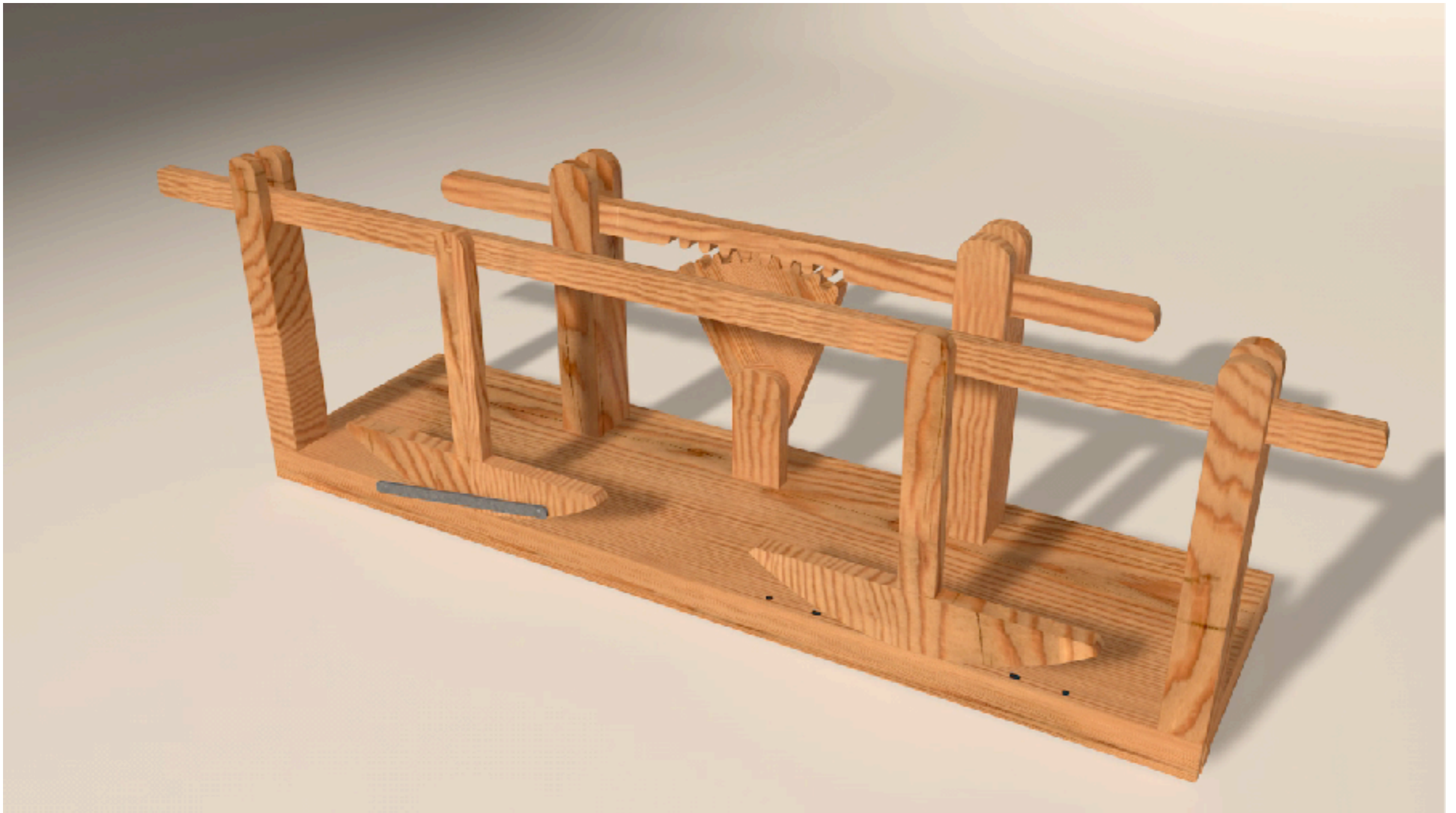



## 3D Metamodeling **Friction**

As is often the case, digital representations are often too good. The problem is common in the heritage domain—how to deal with and think about the **exact representation of color, tinting and toning** for example within **restoration of silent films**?

## 3D Metamodeling **Friction**

From a heritage perspective the question always comes down to **interpretation**. In a similar manner, **friction in relation to movement in Polhem's models also became a question of interpretation**, even if (in this case) we could actually look at the original models and see how they behaved friction wise.



## 3D Metamodeling **Friction**

Within the contemporary heritage domain the relation between **data and object** is currently being negotiated—at least as far as 3D visualisations are deployed and explored.

They will, however, usually cater (in one way or the other) to **interpretation of museological objects** selected for representation—even if institutions are **totally explicit and open about their digital practises**.

- thanks!

